

# PGA Club Racing

# NEWS

VOLUME 25 • EDITION 17.2 • SPONSORED BY PORSCHE CLUB OF AMERICA





THE FIRST CHOICE FOR CHAMPIONS

# MAXIMUM PERFORMANCE AND RELIABILITY



PAGID Racing brake pad compounds offer maximum stopping power, ultimate endurance and consistently high quality for professional and amateur racers alike. EXPERIENCE THE DIFFERENCE IN BRAKING!

ORDERS 800.356.2080    TECH SUPPORT 847.304.5515    ONLINE NORTHSTARMOTORSPORTS.COM

www.pagidracing.com

ORDER

## THE PADS YOU NEED

**In Stock, All the Time, Shipped Free**

WE'RE THE LARGEST U.S. PAGID RACING BRAKE PAD SUPPLIER, WITH THE MOST EXTENSIVE INVENTORY.

PAGID Racing Brake Pads are available in many compounds to fit most applications.

Call us now or use the **PAGID Racing Brake Pad Quick Search** on our website to find the pads you need >>> **FAST!**

**Northstar**  
MOTORSPORTS  
The Original Racing Resource.™



VOLUME 25 • EDITION 17.2 • APRIL - JUNE 2017

### FEATURES

- 4** Dave Elsner — 2016 Michael Melton Award Recipient
- 10** 48 Hours at Sebring and Club Racing Awards Banquet
- 24** Daytona OktoberFast
- 32** 2016 Can/Am Challenge — A Driver's Perspective
- 40** The Latest on Compliance Testing
- 46** PCA Club Racing — A Father's Perspective
- 54** Passing Out On or Soon After Leaving the Track
- 56** Friedman Spirit Award Gets Started at Sebring
- 62** 11th National 944 Cup Goes Transcontinental
- 70** My Journey into Club Racing and Scrutineering
- 76** A Day at Sebring

### COLUMNS

- 20** From the Chair
- 22** View From the Tower
- 36** Editorial License
- 38** From Start to Finish
- 44** Thinking About Rules
- 60** Coaching Perspective

### REMNANTS

- 18** PCA Vintage Racing
- 28** 2017 Club Racing Schedule
- 30** PCA Club Racing Contingency Programs
- 35** 2017 Club Racing National Sponsors
- 68** Event Ads Index
- 74** 2017 Hard Chargers
- 75** Classifieds
- 78** Club Racing National Committee, Advertising Index, CRN Staff

**On the Cover:** Photographer Stephen Krupnick took this race start photo during Daytona's Oktoberfast.

**Club Racing News (CRN)** is the official publication of the Porsche Club of America, Club Racing, and is published quarterly. Written contributions and photographs are welcome and can be mailed to the editor. Opinions expressed are those of the authors and do not necessarily represent the official position of the Porsche Club of America, Club Racing National Committee, its officers or members. Permission is granted to reproduce any material herein provided full credit is given to the author and PCA Club Racing News. PORSCHE®, the Porsche Crest®, CARRERA®, TARGA®, Cayman® and Boxster™ are trademarks of Porsche AG. The editor shall reserve the right to edit and publish only those articles felt to be in the best interest of the members of the Porsche Club of America. Commercial advertising inquiries should be directed to the CRN Advertising Coordinator. Postmaster: Address Change to: PCA Club Racing News, c/o PCA Executive Secretary, P.O. Box 6400 Columbia, MD 21045



# DAVE ELSNER 2016 MICHAEL MELTON AWARD

STORY & PHOTOS BY DAVE ELSNER

Dave Elsner was selected to receive the Michael Melton National Rookie of the Year award in 2016 for his focus on club life, family, and fun, all while achieving great driving success throughout the year.

Dave is a 51 year old retired technology executive who is now living a life long dream. That dream started when he was a kid watching the Indianapolis Grand Prix and playing with slot car sets.

During the '70s his dad had a Porsche 911SC. The race stigma that followed the breed instantly made Dave a fan. He was able to buy his first Porsche in 2006 and his love for racing grew. He started his time as a driver by attending many PCA auto-cross events. In 2008 he attended a

five day Formula 3 race training school at Infineon. There were 37 students; Dave finished 3rd in class. That energized him and the addiction grew, so he went out and bought a Porsche Turbo S and graduated to PDS events.

His times continued to drop, but he realized something significant in the effort to improve: while racing cars is an extreme adrenaline high, it is also very much like the game of golf. In golf it takes 30 years to take 30 strokes off your game. Racing can take years to learn the skills to shave seconds off a lap. Because of that, he knew he had to grow incrementally to be competitive.

Dave also knew he needed a car that put more control in the hands of

the driver rather than the Turbo S, which easily corrected mistakes and drove itself. So Dave went out and bought a GT3RS and, for the next three years, moved through the time trial ranks.

His first major time trial event was the California Festival of Speed. Dave accredits the PCA instructor he worked with as contributing to the success he was having with driving great lines and the times he was achieving. This experience convinced him to join a racing series. Once in the fastest group, he won class championships two years in a row and was asked to join Cup Racing School. The racing school included six classes and track days with great coaches along the way. It also included eval-

uation over a six month period where he was under constant instruction to getting ready for wheel to wheel racing.

After graduating, Dave upgraded to a full 2014 GT3 991 Cup Car and started Big Wave Racing LLC.

Dave is supported by, what he considers, the best Porsche race breed shop in So Cal, Loren Beggs 911 Design in Montclair. In 2016 he ran in 20 separate events and 38 races across the nation. He raced in 21 PCA races and 17 POC races with 10 overall wins, 14 1st place, nine 2nd and eight 3rds. As a result he was named PCA GTC06 West Coast Series champ and placed 2nd in the nation. He also won the POC GT1 Championship and Most Improved Cup Racer. Not bad for his first racing season.

Dave's family, kids and friends have played a significant role throughout the years. It's always more fun with a cheering section. He has four kids and two grandkids that have played a major part by joining him at events. He has a daughter in Vegas who comes to all the Spring Mountain events. His two kids in So Cal join him at California Festival of Speed and Big Willow. His son in Northern California joins him at Laguna Seca and Thunderhill. His dad and sister have attended almost every event in Southern California.

Dave also has a great group of friends all across the country that like to feel the power of racing. When people visit at the track, he always takes the time to show them the garage set up, sit them in the car and explain the technology involved and usually provides a lunch time track ride. They then become his cheering section (how could they not?).

He remembers an event at Laguna Seca. He could see his rooting section stand up and cheer as he moved into first. Elsner said "The energy you get from that is priceless. The smiles are the memories you take away as a reward because, when it comes right down to it, what we walk away with and enjoying is the time with friends and family."



Dave also shared his experience with PCA. “When it comes to PCA events, the things that makes a big difference are the people involved in running the events. They really care about the drivers, they focus on fun and safety, and the recognition given is superb with awards after every event. The fellowship amongst drivers gives you the ease of mind necessary to compete.”

PCA Club Racing events are well organized with great stewardship for the drivers and cars. They hold great kick-off meetings with track and driver instruction and well laid out and organized hot pits. The track staff they choose is always excellent and you get good energy from the announcers. In short, you feel that there is a professional (albeit volunteer) staff at each of these events who are committed to creating an excellent experience for everyone.

Elsner’s favorite part is that the events provide an opportunity to meet so many good people from across the nation that put the drivers and teams first.

Dave’s favorite events this year were the ones that he traveled the farthest for: COTA, Laguna Seca, Thunderhill and Hallett. In all cases, it was about the event. While the tracks were great, all events provided a great local cultural experience with the areas and people involved. He says “this is because this is not just about racing, its about the experience.” Dave also said he had the most fun at the Oklahoma Hallett event and particularly liked that he was able to add horns to his car (see picture) in honor of the great, cowboy locals.

Dave plans to run about 12 PCA events this year along with the Pirelli GT3 Cup series. His goal is to keep improving while staying focused on the great people and the areas he gets to visit. He can’t wait for his first trip to Road America, High Plains, Daytona and a repeat at COTA.

Dave is certainly living a dream and really appreciates the people and culture that follow the Porsche Club of America. ❏



Dave Elsner sporting Worker’s Choice award (upper left)  
 Dave Elsner and his daughter, Heather (upper right)  
 Grandkids Karsyn and Brantley (previous page)

## CORY DAVIS ELSNER

One of my biggest supporters was my 28 year old son, Cory Davis Elsner. Cory died tragically on December 28, 2016.

Cory was killed in a freeway motorcycle accident where he was splitting lanes, got cut off and was forced into the back of a stopped car. The impact into the back of the car caused Cervical Vertebral Disassociation. This is the same way Dale Earnhart was killed and the reason we all wear HANS or similar devices in PCA Club Racing.

As it turns out, there are similar devices for street motorcyclists (Simpson and Laett) and had Cory worn one of these devices, it may have saved his life. As a result, the Elsner family has set up a campaign with a motorcycle safety fund to help bring awareness of these devices to street bikers. Many people ask me how they can help the family during this trying time; “I would ask everyone to encourage any street biker you know to wear one of these neck restraints”.

We honor Cory by putting him in a new place in our lives — through

our memories and by utilizing the impact he made on our lives. Cory had a life of many aspects starting with being a family member and friend with unconditional love for everyone around him.

If you look at the many aspects and his hobbies, you see he truly lived life to the fullest for the short time he was with us. I remember the baseball kid, the kid that dominated at BMX, roller blading, water sports, hockey, Mario Cart, snow sports, rock climbing, skim boarding, down hill speed skate boarding, hiking, paragon gaming, motorcycles, living the Vegas life to the extreme, paramedic, club host, technician and construction.

And his biggest passion was his unbelievable knowledge, support and love for the LA Kings. Cory did a lot in life, but the best part of Cory was the unconditional love for his family and friends.

He never hurt and always gave. For that, and his passion for life, he will always be remembered and each one of us take a piece if his life with us. I take with me... ❏

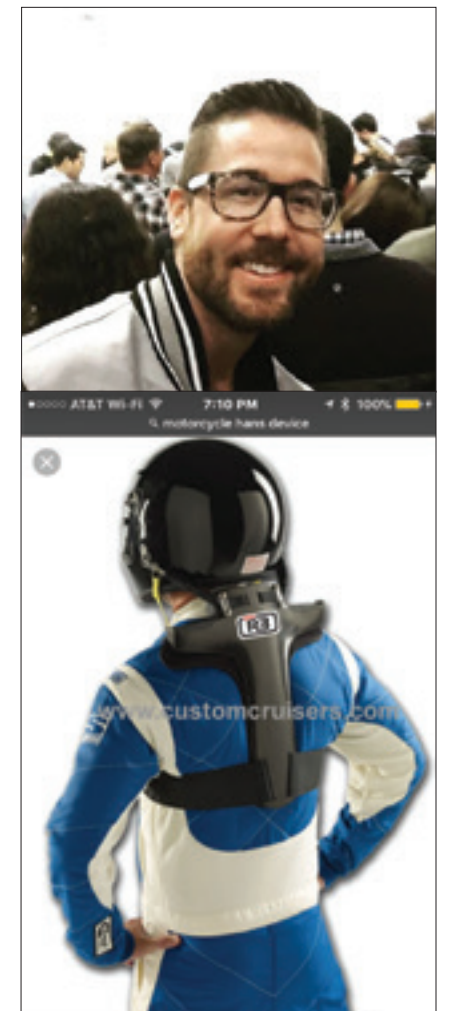

DON'T JUST TAKE CURVES.  
**OWN THEM.**



Experience perfection, enhanced by performance. Our patented, independently adjustable compression and rebound valve system lets you dial in the precise response and feel of enhanced performance. The rebound and compression provides ultra quick chassis settling for track like performance in a street setting. Our passion for perfection shines through in our quality components, like INOX stainless steel or lightweight, race-grade aluminum components and precision click adjusters.

**To order, visit [KWsuspensions.com](https://www.kwsuspensions.com), and take every curve with confidence.**



**VARIANT 3**  
INDEPENDENTLY  
ADJUSTABLE COMPRESSION  
REBOUND DAMPING  
HEIGHT ADJUSTABLE





## 48 HOURS AT SEBRING CLUB RACING AWARDS BANQUET

STORY PCA, PHOTOS BY SKIP CARTER, STEVE RASHBAUM & JUHA LIEVONEN

On February 2-5, more than 400 Porsches competed at one of the largest Porsche Club of America Club Racing events of the year, kicking off the 2017 PCA Club Racing season.

With more than 200 volunteers operating the massive four-day event, PCA drivers enjoyed beautiful weather at the 24th annual 48 Hours at Sebring presented by Champion Porsche at the iconic Sebring International Raceway.

“Drivers from all over the country were able to race again for the first time since 2016 and I’m thrilled to be a part of this huge event once again,” said Josh Breckeen, co-chairman of the 48 Hours at Sebring. “I want to thank our volunteers for the

time and energy they put into the 48 Hours at Sebring. It was very well received and we all love hosting one of the largest PCA events.”

The 2016 PCA Club Racing National Championship Series Awards Dinner, which is hosted by the PCA Club Racing Committee, was held on Thursday at the Chateau Elan at Sebring International Raceway. The dinner banquet honored 2016 podium winners and celebrated the start of the 2017 race season.

“The 2016 PCA Club Racing National Championship Series Awards Dinner kicked off our Porsche-filled weekend with a bang,” said Vicki Earnshaw, PCA Club Racing chair. PCA Club Racing is founded upon

several guiding principles, the most important of which is that racing should be fun, safe and clean. This concept is embodied in the strict enforcement of the 13/13 rule, which provides for sanctions against any driver at fault in any incident involving car damage. To be eligible for the championship, one must race a minimum of three events and finish five races without violating the 13/13 rule.

During the banquet, Earnshaw awarded Dave Elsner with the 2016 Michael Melton Memorial Rookie of the Year Award, which commemorates Michael Melton, former PCA Club Racing driver and editor of Club Racing News. Melton sadly passed away in 1999 of pancreatic

Phone: 203-723-8928

www.SoftronicSoftware.com

email: Info@SoftronicSoftware.com

Porsche tuning software  
**Softronic**<sup>®</sup>  
faster than a speeding bullet

**Softronic<sup>®</sup> is the leading producer of racing and street performance software.**



Softronic<sup>®</sup>-tuned cars have won the GT Class at the Rolex 24 at Daytona and powered every car in the Cayman Interseries.

Softronic<sup>®</sup> software has also powered winning cars and top finishers in the ultra-competitive World Challenge Series, Continental Tire SportsCar Challenge Series, and PCA races from coast to coast.

*Street or track, Softronic<sup>®</sup> software helps you put the competition in your rear view mirror.*



Spencer Cox at the wheel of his GTB1 National Championship-winning Cayman. Enhanced with Softronic<sup>®</sup> software.



2016 Club Racing National Championship trophy winners assembled at the Thursday Victory Banquet

cancer. The award winner is chosen by PCA stewards, who review a large group of rookie racers each year - all of whom participated safely and successfully in at least five races during their rookie season.

Vicki next introduced the Friedman Spirit Award, named in honor of Alan Friedman, the father of PCA Club Racing. This is a new award honoring those in the paddock who show true dedication, loyalty and sportsmanship and best reflect the values shared by PCA Club Racing. This first ever award was given to the Sebring co-chair, Dan Smithyman. He received the award for all the work he has done on the 48 Hours at Sebring event over the years. "I am so honored to receive this heartfelt award," said Smithyman. "PCA is all about camaraderie and friendship, so I'm lucky to be a volunteer for this outstanding organization."

Over the weekend, drivers enjoyed three facets at the world-renowned, 17-turn, 3.74-mile Sebring circuit - PCA Club Racing, Advanced Solo Driver's Education and autocross.

The Green race group, which included the Stock class cars D through K, as well as the SP911s, GT5s and GTC1s, had around 60 entries. Jimmy Martin came in third place in Sprint 1 and improved to a second-place finish in Sprint 2, while



PCA National Vice President Tom Gorsuch



Brumos Championship racer, Andrew Davis



Pirelli North America Nafta Motorsport Manager, Orazio Mastracchio



Jens Walther, President and CEO Porsche Motorsport North America

**RACE WINNING HERITAGE**  
**ADVANCED NON-REMOTE AND REMOTE RESERVOIR TECHNOLOGY 1W, 2W & 3W**

Motion Control Suspension (MCS) brings to you the most advanced race proven dampers. Backed by a staff that has a Race Winning Heritage designing highly advanced, reliable, suspension systems for Porsche cars including several class wins at the 24 hours of Le Mans, 24 hours of Daytona and many more.

2016 IMSA Continental Tire SportsCar Challenge Champion ST Class on MCS Dampers

MCS is a US based company with unparalleled support. All of our products are hand assembled, dyno tested and shipped from our headquarters in Alpharetta, Georgia.

**MCS**  
 MOTION CONTROL SUSPENSION

motioncontrolsuspension.com  
 866.201.1977

Follow us on

Andy Hansen won Sprint 1 and Kevin Violette won Sprint 2.

The Orange group, which consisted of SP1, 2 and 3 cars, a majority of those being 944s and SPBs, had around 55 entries. In Sprint 1, Chris Drake came in first with John Gladwill and Daniel Martinson rounding out the podium in second and third places, respectively.

In the SP3 Class, Dan Martinson and Karl Poeltl went nose-to-tail much of the weekend with only tenths of a second separating them. In the SP2 Class, the reigning 944 Cup National Champion, Fred Beasley, demonstrated once again that his crown is well deserved with additional wins over the weekend.

"The 48 Hours of Sebring continues to be one of the best events each year for the 944 Cup classes with tremendous turnouts and exciting racing on a historically significant track," said Dave Derecola, PCA Club Racing 944 Cup National Coordinator. "Sebring should be on every driver's bucket list."

In other 48 Hours at Sebring racing news, Andy Wilzoch finished second in Sprint 1 with the fastest overall lap time of 2:04.767 and then came back to beat the competition by winning Sprint 2 in his Flying Lizard 2016 Porsche GT3R. Wilzoch competed in the same car in the 2016 Pirelli World Challenge. He was part of the Blue group, which consisted of some of the fastest cars at the event, including GTA and GTC cars.

PCA member Roger Johnson spent his fifth year at the 48 Hours at Sebring live-blogging the first 2017 club race. Fans, friends and family were able to check out the action live throughout the weekend on the 48 Hours at Sebring website and PCA.org.

In addition to the racing, there were lunch time track tours available for a charitable contribution.

Once the track went cold, things did not quit. Starting with the 2016 Awards Banquet on Thursday, Friday night had the second annual *Speed Showcase*, a great *meet and greet* in the Gallery of Legends building. There

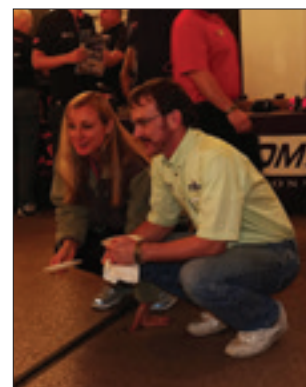

Vicki Earnshaw presenting the Friedman Spirit Award to Dan Smithyman (left)

Club Racing Timing & Scoring Chair, Michael Wingfield, explaining the intricacies of the 962 underbelly (upper right)



Michael Levitas leads Ron Charles #02 and Perry Bortolotti #884 thru Turn 17



Jens Walthes with Carlos and Michael de Quesada, who were drivers and GTD class winners at Daytona the week before



Kevin Jeanette told us the story about how this Dyson 962 came back from the dead



WE ARE FAST AND STEADY  
AND ONLY BRAKE WHEN WE HAVE TO.

**PROXES**

High Performance That Never Rests.



WE ARE TOYO. ALL OR NOTHING. **TOYOTIRES**

©2015 Toyo Tire U.S.A. Corp.



was hot food and cold beverages. It was a great opportunity to mingle with the drivers, vendors and sponsors and other volunteers.

There were two very special vehicles on display. The mystery car, uncovered Friday night, was a recently restored Porsche 962 in Dyson livery. Gunnar Racing's Kevin Jeannette told a very interesting story about this car, how it never raced (wrecked in practice before it had the opportunity). A new chassis was shipped over from Germany, the VIN transferred to the new chassis, and the one we saw here went into storage.

The second special car was brought here by Alegra Motorsports and Sun-coast member, Carlos de Quesada. The 911 GT3 R had a GTD class win just one week earlier at the 24 Hours at Daytona, driven by Carlos, his son Michael, Jesse Lazare and Michael Christensen. The car still had all the dirt and grime from the 24 hour race. It looked fabulous.

For my wife, Suesan, and I, this was our second consecutive year attending the 48 Hours at Sebring. In particular Suesan loves being able to work from our hotel room while looking out the window watching and listening to the race cars whizzing through the hairpin. That's not something you get at most racetracks!

For me, having this great hotel a stone's throw from the track is incredibly convenient. As Club Racing News editor, Sebring is a great opportunity for me to meet drivers, vendors, key management personnel and other volunteers. This is where the beginning of many of our CRN articles come from.

This is also a wonderful opportunity to visit Florida when the weather is almost always perfect. About the only thing that I missed was an opportunity to eat at one of my favorite restaurants, Bern's Steak House in Tampa. Being this close and not figuring out a way to make that happen is rare. But then, there is always next year. So, thanks to everyone for the outstanding job you all did! 🍀



For most of the PCA national staff at Sebring, our responsibilities start with the Thursday noon combined lunch and staff meeting.

As you can see from the two photos taken immediately after that meeting (the top being key event staff and the bottom our Club Racing staff), it takes a lot of talent and coordination to make an event like this happen.

Terry Richard, Sally Farmer and Frank Chaney, three grid workers who have been volunteering 15-20 years at this event (left)

Two long time key volunteers at Sebring are Sherry Fabel and Ellen Riley (right)



Those guys in the booth, announcer Dick Kjellsen and live blogger, Roger Johnson

If you don't think that the 944s are a tight group, check out this race start!

Scruts take a moment in the pits during a very busy weekend

CRN Ad Manager, Ilko Nechev showing off our product to BGBs John Tecce

This "Hall of Fame" sign hanging on the side of the tower pretty much says it all

The tire rigs were beyond busy at times

Steve Rashbaum and Dave Herndon are showing very little respect for this editor



# Vintage Racing

I am Fred Pfeiffer, newly appointed PCA Club Racing Vintage Coordinator. I am a Potomac member and have just finished six years as their Race Chair.

I race a 914-6 in VRG and now PCA Vintage racing.

Having staged the inaugural Vintage Group race at Potomac's Silver Anniversary event this past September, PCA Club Racing is committed to adding more cars and drivers as well as more events across the country.

If you own or drive a '83 or older AIRCOOLED Porsche race car and would like to race it, we have the place for you. If you have a four-cylinder car like a 356, 912 or 914 that struggles in our usual classes, we have the place for you. If you have an older car that you have swapped engines in and puts you in a race class that is not favorable, we have the place for you. If you are currently racing your 911 or 914 against newer cars with twice your horsepower, we have the place for you.

Talk to the twenty drivers that made up our first race group and see how excited they are about Vintage racing with PCA. You will find that they had more seat time, in a better format and felt more competitive than in many years.

If you are a region race chair and want to add more entries and spark more interest in your event, we have an answer for you as well. Our desire is to have four races on the Vintage schedule this year. Ask what we are all about.

To learn more please contact me at: fpfeiffer@atlanticbb.net or call me at: 301.707.9472



## Upcoming Events

**July 14**  
Riesentoter Stuttgart Challenge  
Monticello Motor Club

**September 22**  
Potomac Club Race  
Summit Point Motorsports Park

**October 13**  
Pittsburgh International  
Pittsburgh Int Race Complex

**November 11**  
Motorsport Ranch



# Apex Performance

Premier Racing Outfitters



**NEW! All helmets include integrated electronics and patented helmet release system.**



**Durable Trackside Gear Bags**



**Street & track pads for your Porsche**

Three compounds: DS2500, DS1.11, DSUNO  
Long-lasting, Easy on discs, No judder or vibration.



**ALSO AVAILABLE!**



Receive a **FREE** fleece lined helmet bag with every SA2015 helmet purchase!



It's the most effective heat prevention system.

Full systems, replacement parts & accessories available



Cool-a-Clava  
Helmet Cooling Insert



# Apex Performance

Premier Racing Outfitters

Visit us trackside, new showroom or online at [www.apexperformance.net](http://www.apexperformance.net)

Visit us on Facebook to view our track schedule

**Orders 866-505-2739**  
**Tech 843-299-0997**

Ask for your PCA discount! (available on most items)





# From the Chair

VICKI EARNSHAW • PCA CLUB RACING CHAIR

The Porsche Club of America National 2016 Champion Winners were recognized at the Chateau Elan Banquet on turn seven of the International Sebring Race Track on February 4. The Champion racers were toasted for attaining their podium by racing at least five races over three events. Many of these racers attend many more races to acquire their winning event points.

One of the basic founding principles of PCA Club Racing is safe, clean and fun racing. This principle is embodied in the 13 / 13 rule. These Champion racers, while acquiring the points to win their classes, cannot have a 13 sanction. So here's a toast to the Champions who raced competitively and clean to earn this honor.

We also acknowledged our sponsors at the Championship Banquet. It is their support that has allowed us to improve the program. The banquet also recognized the volunteers of the club racing program in appreciation of their dedication and many contributions. At the end of the evening we all enjoyed speaker Andrew Davis, a professional racer who helped win the very championship for Brumos. Andrew entertained us with his stories of lessons learned at Sebring and other race tracks.

The first Friedman Spirit Award was presented at the Sebring Banquet. Alan Friedman, the founder of Club Racing, started the program with unselfish fortitude to start a one mark racing program. The goal was

to have a place for Porsches to race in a competitive but fun arena. The award was initiated from a suggestion of a fellow racer who wanted us to remember Alan and what he accomplished to start the program. The Friedman Spirit award honors those in the paddock that show true dedication, loyalty and sportsmanship and best reflect the values shared by PCA Club Racing.

This year, we were delighted to present the inaugural award to Dan Smithyman, co-chair of the 48 hours of Sebring. Dan has chaired the Sebring event for 10 years. His leadership, with over 150 volunteers, welcomes the racers to one of our largest events of the year. It has always been my pleasure to work with him because his attitude of "how can we make this happen for the racers" comes first. Congratulations, Dan!

In the late 90's a racer, in the slowest 911 on the race track, was given the name "The Rookie." Michael Melton gave support to his friends in the paddock and to the volunteers and to the national staff. He was also editor of Club Racing News. Michael passed away early, but his friends wanted his memory and his spirit to remain with PCA Club Racing. The Melton Rookie award is presented annually to a first year racer who completes five "clean" races in that year and is recognized by the stewards of Club Racing to have this camaraderie that Michael Melton shared. The award this year is presented to David Elsner from Califor-

nia who races with us in his GTC-5 car. Congratulations, David!

Sebring was the initial race for our new 13/13 procedure. Starting in 2017, if a racer is at fault for an incident and is issued a 13 sanction, and the incident was not a gross error, the car is safe and the driver has the right attitude... The driver may be allowed to return to complete the race weekend event. This is in contrast to the previous rule where the driver was excluded from driving the rest of the event. The 13 probation starts immediately and the driver is aware that another sanction that weekend would mean a suspension.

An unexpected situation came up with this new procedure at Sebring. Two Boxsters had contact (I know, who would expect that). The drivers did not know each other previously to the Sebring race. The *not at fault* car received damage that could not be fixed at the track, but the *at fault* driver invited the other driver to share his car during the enduro. Now *that* is PCA Club Racing!

The 2017 schedule will include the new configuration of the Pitt race track in September. Putnam Park, which has been resurfaced, is back on the Club Race schedule.

A *shout out* to Golden Gate region, who is putting on five PCA club races this year, including Sonoma and Laguna Seca.

The *Cayman GT4 Trophy East Series* will have eight races. Three new events for the Clubsports will be Barber Motorsports Park in conjunction



**2017 WEST COAST SERIES**

The West Coast Series is a PCA club racing points competition comprised of all the PCA club races that occur on the west coast of the USA. Historically, club racing in the PCA has been most popular on the east coast, and this series was created (starting with the 2014 season) to encourage west coast club members to take up club racing by providing them with the increased competition and sense of camaraderie that comes with having one's own competitive series. All PCA club racers are eligible to participate and all entrants to the listed events are automatically entered into the series. You may review the rules on the Club Racing website <https://www.pca.org/rules-licensing-forms> For more information: [wcs@pca.org](mailto:wcs@pca.org)

**2017 Sponsors**

**TARETT ENGINEERING**  
Competition Suspension Components

**HAGERTY.**  
CLASSIC CAR INSURANCE

**PIRELLI**

**GEARTIE**  
REUSABLE RUBBER TWIST TIE™

**clubregistration.net**

**SPEED FREAKS USA**

March 18-19  
Thunderhill Raceway

April 21-23  
Auto Club Speedway

May 27-28  
Buttonwillow Raceway

June 2-4  
Mazda Laguna Seca Raceway

June 17-18  
High Plains Raceway

June 30 - July 2  
Sonoma Raceway

September 2-3  
Thunderhill Raceway

September 15-17  
Utah Motorsports Campus

September 30 - October 1  
Willow Springs Raceway

November 11-12  
Buttonwillow Raceway

with the Barber Historics, Mosport and Monticello.

Our first ever Vintage race group at Summit Point last year generated interest for the 1983 and older air cooled cars. They raced in their own run group with four simple classes. All racers had a PCA racing license and adhered to our safety rules. Many of these drivers went out of their way to thank us for giving them a place to race in PCA.

Our calendar has Summit Point, Monticello, Pitt Track and Motorsports Ranch on the schedule, reaching our goal of four vintage races in 2017. As a racer or an event chair, if you have interest in a Vintage group, contact Fred Pfeiffer at [fpfeiffer@atlanticbb.net](mailto:fpfeiffer@atlanticbb.net). The rules are on our website: [pcaclubracing.org](http://pcaclubracing.org)

The continuing action items for 2017 are the new PCA Club Racing website, an enduro for 2018, contingencies for racers and compliance of racing rules. Our 2017 goals for PCA Club Racing are to increase the rac-

ing membership and to continue to develop a scrutineering program to keep the class fields level and fun. At Sebring the new equipment purchased for this goal was visible. Our team began working with this equipment and training out personnel. The gear check device and borescope were both run through their paces. You can expect to see more of this in the future. Many comments came across my computer last year regarding possible short comings of our rules enforcement. To allow scruts more time to use this equipment, at some events we will be sending extra scruts in just to evaluate car compliance. This will allow them to concentrate on this process and achieve the goal we have set for 2017.

I challenge each of you to bring another racer into PCA Club Racing, allowing us to continue to maintain our healthy membership numbers.

Enjoy Your 2017 Racing Season.  
Vicki

Quick Release Steering Wheel Hub



Order online at  
[www.tcracing.org](http://www.tcracing.org)  
Tel: 901-767-1111  
Email: [tcracingporsches@aol.com](mailto:tcracingporsches@aol.com)

TC Racing's quick release mechanism makes it easy to insert and remove the steering wheel from the hub. Simply pull the twin pins. Direct bolt-on installation to Momo, Sparco and other steering wheels.

- Hub: \$78
- Quick Release and Hub: \$275
- NEW: Quick Release for MOMO





# View From the Tower

BRYAN HENDERSEN • CHIEF STEWARD

## CAYMAN CLUBSPORT IMPACT AT OUR RACES

I have heard many rumors about the effect of the *Cayman GT4 Clubsport Trophy East Series* on PCA Club Racing. Contrary to many rumors, the series has been extremely good for PCA Club Racing. And, also contrary to many rumors, it has had very little, if any, negative impact concerning schedules and track time for racers at the events where the series has been run.

The *Clubsport Series* has purchased track time from regions and zones who hold PCA Club Racing events. This helps events become more financially stable. In most cases that time has come by replacing a DE group that had been run at those events. In other cases a 4th or 5th group has been added.

Since the *Clubsport series* runs under different rules, it is necessary that we use different drivers meetings. This allows us to keep the track hot rather than shutting it down for meetings. For example, with one race that went from four groups in 2015 to five groups in 2016, the Friday schedule started 30 minutes earlier (8:00 am) than in 2015 and ended for the traditional run groups at the same time as the year before without *Clubsport*. On Saturday, at that same race, the day started 15 minutes earlier and finished 20 minutes earlier for the traditional groups. The Sunday schedule started and ended at the exact same times for the traditional run groups. In no case were the on-track run times reduced and the exact same session contents were used. We have worked very hard to minimize the impact on our club racers.

The broadening of our financial base brought about by adding the *Clubsport Series* has helped us in many ways. Purchasing new equipment became a smaller percentage of our overall budget, which allowed us to make those expenditures with more confidence.

We replaced our mostly 20-year-old radios with new, more efficient digital units. We have continued to upgrade timing and scoring equipment and add to our scrutineering equipment. We have added scrutineers to many races to better level the playing field. We have added a PR firm that works *Clubsport* events and a couple of other large races each year (Sebring and Road America in 2017). When they are there they handle all trophy presentations and write press releases and other information featuring all of our drivers, not just those in the *Clubsport series*. All of this has created interest from potential sponsors, which we believe will result in more contingency programs and good things for all our racers.

The new radios add features we did not have before, some improve safety. They have five frequencies and can use all five with digital or analog modulation. With digital, the steward's radios have override capability over the others. For example, if the steward is working to get the pace car on track and a scrut (who has been working under a car and is unaware of the ongoing pace car communication) steps out to make a call at just the wrong time, the steward can still transmit, which turns off all the

other transmitters in our system, allowing the pace car transmission to go out on time. The radios are also encrypted due to the nature of digital systems. Others will no longer be able to monitor PCA staff transmissions.

We will use the analog frequency 464.8250 251 DPL to transmit specific instructions to teams that can monitor that frequency. This may include who is leading at a full course double yellow, behavior around incidents and other specific instructions to a team who can then notify their drivers.

By the time you read this, many of you may have seen the increase in scrutineering activity. We were certainly more active at Sebring, which created much discussion. A few issues were uncovered as well as the misinterpretation of some of our rules. Scrutineering is for you, the racers. The increase in compliance checking is to work on our goal of making sure each of you has a fair chance to win. Please cooperate with our scrutineers when they want to look at your car. Frankly, not allowing them to look is not an option.

One thing that surprised us at Sebring was the increase in drivers reporting incidents to black flag after the race as required. There were many light touches with very little or no damage reported. The ones I am mentioning were all rub outs. This is a good thing. We get a better handle on what is happening and racers become more aware of contact and what they can do to prevent it. It will ultimately make racing safer.

### Increase in incident on straights

I mentioned a few months ago that we are seeing an increase in incidents on what is essentially a straight. That would be on a light bend where drivers are at full throttle, do not make a clear turn-in and do not go to an apex. It would be an area where drivers can easily go three wide. Depending on what is happening, these no turn-in/no apex situations are treated exactly like a straight for incident investigation.

Like an incident on the straight, most issues are caused by the lead driver making a blocking move a bit too late and after the trailing car has overlap and very little ability to avoid contact. Like on a straight, if you make a move to impede a driver who has a run and will likely pass you cleanly before the next brake zone, and there is contact where the overtaking driver could not bail out very late in the pass attempt, the leading driver will usually be found at fault. We hear "he had responsibility to make a clean pass." The problem arises when the overtaking driver did everything he could do to make a clean pass and got

hit as he was going by the car later found at fault.

We have had our first race under the *video required* rule. It made a profound difference for the stewards who were there running the event.

Drivers benefit from more video and stewards increase their ability to be sure they get the decisions concerning incidents correct. We have known for a long time that, when we have video, it is much easier to confidently find the party who is at fault. At this race we had multiple videos of almost all incidents, including many more than usual from cars behind, and even cars ahead who had rearward looking video. This is a good thing for all involved, both drivers and stewards.

I had an interesting comment after an incident in a recent race. After viewing a video from behind, the driver indicated that he was attempting to pass a car who was even with him at turn-in, and he was slightly ahead of at the apex. He believed the other driver should have backed out and given him the track-out. I don't know where you can read that into our rules. If cars are even at turn-in, they

both owe each other racing room until one is clearly ahead, in which case the pass is complete or successfully defended. In this situation, the driver attempting the pass hit the other car who still had significant overlap at track-out and was surprised that he was found at fault.

We have, in the past, had issues with split starts where the second group did not have much of a real start. At Road Atlanta last year, we observed the entire second group come over the hill in single file, seeing the starter for the first time. Racing had obviously started well before it should have. In the Sebring drivers meeting, before the split starts, I made a forceful comment concerning this. A driver or two did not appreciate my comment. At this race the split starts were perfect. There was good racing into the first turn with multiple rows going three, four and even five wide. No incidents were reported on the starts. Great racing guys! The front row did their job of controlling the field for the start. Everyone had a fair chance. EXCELLENT!

Be Safe. Go fast.

**GREAT PLAINS REGION 25th ANNIVERSARY**  
**CARRERA GT AT MPH**  
 JUNE 2 - 4, 2017 • SPONSORED BY PORSCHE OMAHA

**FRI: TEST AND TUNE (DE RULES)**  
**SAT & SUN: THREE SPRINT RACES FOR EACH CLASS**  
**SATURDAY NIGHT SOCIAL**

**REGISTRATION: register.pca.org**  
**MORE INFO: gpreclubreg@centurylink.net**  
**or www.gprpca.com**

MOTORSPORT PARK HASTINGS  
 2.15 MI • HASTINGS, NEBRASKA

REGISTRATION OPENS APRIL 17



# DAYTONA — OKTOBERFAST

STORY BY SKIP CARTER, PHOTOS BY STEPHEN KRUPNICK, MIKE KLASKIN & JUHA LIEVONEN

Last October was my third trip to Daytona International Speedway. After decades of hearing about this place (but never getting very close), Rennsport Reunion II was scheduled for March 2004. There wasn't much thought about "should I go" (I was still kicking myself for missing Rennsport I at Lime Rock). So, my feeling on this one were pretty much "get tickets; book a flight."

I took my then 16 year old daughter, Connie. She is a great, self motivated kid who always worked hard, did very well in school. I would occasionally take her out of school for some "dad time" without having to worry about her struggling to catch up. A day trip to LA to show her some sights, etc. Well, Rennsport II was one of those *dad times*.

The only thing I want to say about that first visit was the feeling going through the tunnel for the first time and seeing it for the first time. I don't remember getting down on my knees and kissing the ground, but the impulse was certainly there.

The history that has been created here! If you even just take a look at the Porsche history, it is incredible... To name just a few:

1. Since its appearance in 1962, Porsche is the most successful manufacturer on the road course with 22 overall wins.
2. From 1977 to 1987, Porsche compiled 11 consecutive overall wins at the Rolex 24 (a manufacturer record).
3. Porsche has the most "one-two" finishes ever - 12.

4. The 1968 1-2-3 sweep of the 907 Longtails is simply iconic.

My second visit was Rennsport III, just as amazing as II. A lot happened to me between the 2nd and 3rd visits, including getting a track car, becoming a club racer, then becoming CRN editor. I felt (and still do) a strong need to get to every PCA Club Racing venue and to do a story on each of them: big, small and in between, which is partly why I was able to hit Sebring, Miller, High Plains and Daytona in 2016, in addition to the tracks I normally drive.

This was the final 2016 race for the Cayman GT4 Clubsport Trophy Series East, and I had not seen them in person, so this was my last opportunity and, after all, it was Daytona!

## Out Of The Box... Into The Winner's Circle

INTRODUCING...

# 331 AND 332

ENDURANCE  
COMPOUNDS



ALEGRA  
MOTORSPORTS

- CarbonMetallic® Race Pads
- ZERO FAILURES™ V3 Discs
- ZERO DRAG™ Calipers
- RH665 Racing Brake Fluid



**1st** In GTD  
**2017 Rolex 24hr**  
Daytona International Speedway



www.pfcbrakes.com

800.521.8874

This weekend was also the championship race for the 944 Cup East series, so there was a lot of racing going on and a lot of trophies involved.

Stephen Krupnick, another Grand Prix region friend and fabulous photographer (check out his website at [TravelsWithStephen.com](http://TravelsWithStephen.com)), flew out with me to shoot the event. Stephen is constantly traveling. In the last several months, that I recall, he's flown to Cartegena, Vermont, Scotland and Texas. He's been to every continent, and most twice. Mt Everest, Nepal, etc. I love his photos of the shut down auto plants in Detroit.

So, this trip to Daytona was great. We came a couple of days early to check out the area, just one week after the hurricane hit. I was amazed at how much cleanup had been done in just one week. There were more piles of fallen trees and other debris piled up ready for pickup.

At Daytona I was able to meet a lot of drivers and several of our advertisers, always working on stories for CRN. I attended the Clubsport Awards Banquet and learned a lot about that series. I'm constantly trying to learn the protocol for photographer access at different tracks. What I learned at Daytona was "just because one corner worker tells you one thing, that doesn't mean that a different corner will have different rules". Oh well. 🏁

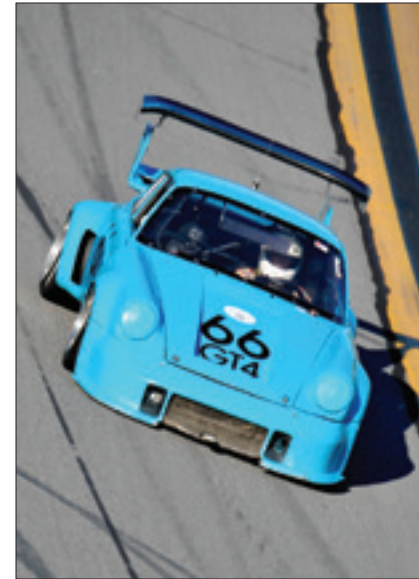
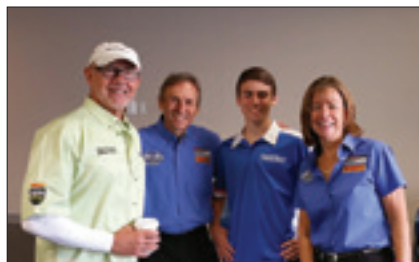



# 2017 Club Racing Schedule

DATES	EVENT / ADDITIONAL INFO	REGION/ZONE	EVENT/CONTACT
Feb 3-5	<b>Sebring International Raceway*</b> 944 Cup South	Suncoast Florida/Gold Coast	Dan Smithyman 954.224.4717 dansmithyman@bellsouth.net
Mar 3-5	<b>Circuit of the Americas*</b> 944 Cup Southwest	Hill Country	Tuffy von Briesen 703.980.7839 dvb0415@gmail.com
Mar 18-19	<b>Thunderhill Raceway</b> 944 Cup West / West Coast Series	Golden Gate	Richard French 650.995.6100 rf@richardfren.ch
Mar 31-Apr 2	<b>Road Atlanta*</b> 944 Cup South / Cayman GT4CS East Series Races	Peachstate	Mike Hopper 404.379.6877 hopperm993@gmail.com
Apr 21-22	<b>Lime Rock Park</b>	Conecticut Valley	Peter Clark 603.494.7080 clarkpeterc@gmail.com
April 21-23	<b>Auto Club Speedway*</b>	Zone 8	Tom Brown 619.491.150 tb911@tbssoftware.net
May 5-7	<b>Mid Ohio Sports Car Course*</b>	Mid Ohio	Mike Stoner 614.205.3389 mds4200@gmail.com
May 19-21	<b>Barber Motorsports Park</b> Cayman GT4CS East Series Races — Invitation to GT4CS East Series — no open registration	NOT A PCA CLUB RACE	
May 19-21	<b>Gateway Motorsports Park*</b> 944 Cup Midwest	St Louis	Dan Sokol 314.971.4742 ibinmo@gmail.com
May 27-28	<b>Buttonwillow Raceway Park</b> 944 Cup West / West Coast Series	Golden Gate	Richard French 650.995.6100 rf@richardfren.ch
Jun 2-4	<b>Watkins Glen International*</b> 944 Cup North / Cayman GT4CS East Series Races	Zone 1	Mike Bryan 905.726.9027 mike@brycorp.ca
Jun 3-4	<b>Motorsports Park Hastings</b> 944 Cup Midwest	Great Plains	Kurt Halvorsen 402.203.2331 bimmers218@cox.net
Jun 17-18	<b>High Plains Raceway*</b> 944 Cup West / West Coast Series	Rocky Mountain	Brian Learhy rnrClubRace.com beleary36@yahoo.com
Jun 23-25	<b>VIrginia International Raceway*</b> 944 Cup South / Cayman GT4CS East Series Races	Zone 2	Phil Grandfield 757.635.0892 Filthyf14@yahoo.com
Jun 30-Jul 2	<b>Sonoma Raceway</b> 944 Cup West / West Coast Series	Golden Gate	Richard French 650.995.6100 rf@richardfren.ch
Jul 7-9	<b>Putnam Park*</b> 944 Cup Midwest	Ohio Valley	TBA
Jul 14-16	<b>Monticello Motor Club*</b> 944 Cup North / Cayman GT4CS East Series Races	Riesentöter	Chris Karras 215.850.4040 rtr-racechair@nazg.com
Jul 29-30	<b>Brainerd International Raceway*</b> 944 Cup Midwest	Nord Stern	TBA
Aug 4-6	<b>Canadian Tire Motorsports Park*</b> 944 Cup North / Cayman GT4CS East Series Races	Upper Canada	Terry Casson 613.848.1301 club-race@pcaucr.org
Aug 18-20	<b>New Jersey Motorsports Park*</b> 944 Cup North	Schattenbaum	Dan Petchel 609.298.2277 carsinc@comcast.net

DATES	EVENT / ADDITIONAL INFO	REGION/ZONE	EVENT/CONTACT
Sep 2-3	<b>Thunderhill Raceway</b> 944 Cup West / West Coast Series	Golden Gate	Richard French 650.995.6100 rf@richardfren.ch
Sep 2-4	<b>Road America*</b> 944 Cup Midwest	Chicago	Keith Clark 630.514.5937 kc_design@sbcglobal.net
Sep 15-17	<b>NOLA Motorsports Park*</b> 944 Cup Southwest / Cayman GT4CS East Series Races	Mardi Gras	John Crosby 504.909.267 jlcrosby@crosbydevelopment.com
Sep 15-17	<b>Utah Motorsports Campus*</b> 944 Cup West / West Coast Series	Intermountain	Otto Silva 801.899.3511 otto@nephites.com
Sep 22-24	<b>Summit Point Motorsports Park*</b> 944 Cup North / Vintage Run Group	Potomac	Gary Baker 301.642.4005 clubrace@pcapotomac.org
Sep 30-Oct 1	<b>Willow Springs International Park*</b> 944 Cup West / West Coast Series	San Diego	Greg Phillips 619.395.7506 phigreg@gmail.com
Oct 7-8	<b>Hallett Motor Racing Circuit</b>	Cimarron	Jon Jones 918.200.4044 cimarronpca.events@gmail.com
Oct 13-15	<b>Pittsburgh International Race Complex*</b> 944 Cup Nationals East (M) (N) (S)	Allegheny	TBA
Oct 27-29	<b>Daytona International Speedway*</b> 944 Cup South / Cayman GT4CS East Series Races	Zone 12	TBA
Nov 11-12	<b>Motorsport Ranch*</b> Vintage Run Group	Maverick	Pat Heptig 214.649.7909 pheptig@heptiglaw.com
Nov 11-12	<b>Buttonwillow Raceway Park</b> 944 Cup West / West Coast Series	San Diego	Greg Phillips 619.395.7506 phigreg@gmail.com

\* Indicates an Enduro

*“Summertime, and the living is easy”*

## 2017 BIR DE & CLUB RACE - JULY 28, 29, 30

- Hosted by Nord Stern – the definition of *‘Hospitality Excellence’*
- 3 days of track time - Friday test & tune, Saturday & Sunday competition along with camaraderie, charity auctions, that famous ‘Up North’ ambience, social post-track action . . . BIR has it all.
- Brainerd International Raceway in Baxter, MN – just two hours north of the Minneapolis-St. Paul metro area – brainerdraceway.com
- Driver Ed options – Registration, clubregistration.net
- A ‘Bucket List’ Track & Race!

# PCA CLUB RACING CONTINGENCY PROGRAMS

BY STEVE RASHBAUM

Below is an outline of the various contingencies available to racers. An overview of the award guidelines and forms can be found at: [www.pca.org/rules-licensing-forms](http://www.pca.org/rules-licensing-forms)



#### Bob Woodman Tires:

- All classes running on Hoosier, Toyo or Yokohama tires.
- Guidelines/forms at: [www.BobWoodmanTires.com/PCAcontingency](http://www.BobWoodmanTires.com/PCAcontingency)



#### Pirelli/JX2:

- All classes running on Pirelli tires.
- Guidelines and forms can be found at: <https://jx2pg.com/contingency/jx2-contingency-form/>



#### Toyo Tires:

- SPB and SPC classes
- Guidelines and forms can be found at: [www.toyoracerrebates.com](http://www.toyoracerrebates.com)



#### Hawk Brakes:

- SP1-3
- One set of brake pads to class winners of championship points races having more than 5 starters.
- Certificates will be sent to winners.



#### Pirelli/JX2:

- GTC3-6
- Tires awarded to class winners of championship points races having more than two starters.
- Certificates will be sent to winners.



#### Pirelli/JX2:

- GTB1 "Triple Trofeo Championship".
- Guidelines can be found at: <https://www.pca.org/rules-licensing-forms>

We would like to thank our sponsors for their generous support of PCA Club Racing



## MORE HORSEPOWER, LESS WEAR

Millers Oils is proud to be a 2016 PCA Club Racing Sponsor.

Award winning Nanodrive engine and gear oils deliver extreme performance.

Added protection to engines and gearbox

Up to 3000 race miles life

Tri-Ester, PAO and NANO-Technology

Superior film strength

80% increase in load bearing



Dealer inquiries welcome  
Performance Racing Oils  
Tel: 865-200-4264  
[info@performanceracingoils.com](mailto:info@performanceracingoils.com)  
[PerformanceRacingOils.com](http://PerformanceRacingOils.com)  
\*contact Performance Racing Oils for details.



"Learn more about Millers Oils"





# 2016 CAN/AM CHALLENGE THE DRIVER'S PERSPECTIVE

STORY BY KATHLEEN WONG, PRESIDENT, PCA UPPER CANADA REGION

The first sanctioned PCA Upper Canada Region Club Race took place at Mosport in 1996. The August 2016 Can/Am Challenge Club Race was the 21st running of our race at the same exciting track — Canadian Tire Motorsport Park (“CTMP” or Mosport).

I have been participating in the UCR Drivers’ Education (“DE”) program since 1998. Dave Osborne (DE Track Chair), Del Bruce (Worker Assignment) and Stephen Goodbody (Chief Instructor) have built a first-class DE program, and I have witnessed how the program has evolved over the last 18 years.

Almost every single DE event was sold out during the last several years. This is a true testament to the hard

work and dedication of the track team and volunteers, and the enthusiasm of the DE participants who show their commitment to the event every year.

And, huge kudos to the legion of UCR volunteer instructors who work tirelessly to help students develop advanced driving skills.

Being a race car driver was one of my childhood dreams. The DE program was a great stepping stone for me to get into PCA Club Racing. After 10 years of DE I bought a 1989 944 Turbo S and turned it into a race car. I received my PCA Club Racing license in 2008 and participated in our Mosport event every year since. I still use DE weekends to practice for this major event of the year.

Frankly speaking, I am one of the slowest cars on the track, usually near the back of the pack. I have never been on the podium. So, I always get the following question from my friends: “Why do you spend so much money maintaining your race car every year and participate in a race that you will never win?”

## Why I never win and still smile

This is my long answer: “It’s all about the club racing experience. At the rolling start of a race, adrenaline is pumping through my veins when I and the other 40+ *angry* racers sit revving our engines before roaring down the front straight of Mosport when the green flag is waived. It’s exhilarating when me and another car are go-

**10th Annual!**  
**SCHATTENBAUM SHOWDOWN**  
August 18 - 20, 2017  
**THUNDERBOLT RACEWAY**  
NEW JERSEY MOTORSPORTS PARK

Registration opens  
Monday, July 3rd 10:00 pm EDT  
<http://register.pca.org>

Presented by  
Schattenbaum Region  
Porsche Club of America

Find up-dates  
and info at:  
[www.schattenbaum.org](http://www.schattenbaum.org)

Bob Helm

**WHERE DO YOU WANT TO FINISH?**

MOTON SUSPENSION TECHNOLOGY  
AST SUSPENSION

MOTON / AST SUSPENSION NORTH AMERICA  
17925 SKY PARK CIRCLE SUITE F IRVINE, CA 92614 | 949-502-6243 | [INFO@MOTONSUSPENSIONUSA.COM](mailto:INFO@MOTONSUSPENSIONUSA.COM)

ing side-by-side, a door handle apart, at high speed going through turn 1.

Then, it depends on who gets the inside line at Turn 2, (my favorite turn) - a blind, high-speed, downhill, double apex, off-camber turn with an elevation drop of 45 feet. I always try to protect my turf at Turn 2 and hold the inside line so my fellow racer still has enough room to be hanging on the outside so we head to Turn 2 side-by-side.

This is the excitement of club racing, and the challenge is to take that beast to the limit but still have control of it at the end of a race. To be able to finish all my races during a race weekend is an accomplishment for me.

The PCA Club Race is a very well-run event. I feel very safe racing on track because all our racers have the utmost respect for each other. Even though we are racing hard out there, we are all friends at the end of the day. And, we all enjoy the camaraderie and competition of pure club racing. There is no prize money for winners in a PCA Club Race, and the best reward is that both the driver and the race car go home in the same condition we arrived in."

Bruce Boeder, PCA National Steward and a PCA Club Racer since 1992, was at the 2016 Can/Am Challenge. At the orientation meeting he gave the following tips to rookie racers:

A: Awareness - Be aware of what is going on around you. And watch the flag stations.

B: Back out and back off - If you can't make the pass cleanly, back off and be patient and wait for another



opportunity. It is the responsibility of the overtaking driver to complete a safe pass. The driver being passed should hold onto his or her racing line and let the overtaking driver go off-line to make a pass.

C - Co-existence - practice friendly co-existence and take care of your fellow racers.

D - Don't take unnecessary chances  
E - Something in hand at all times. In other words, don't drive at the ragged edge.

If you are curious about how I did at 2016 Can/Am Challenge Club Race, here is my *achievement* over the weekend: I raced in stock class "F", one of the largest classes. I know I will never get on the podium, so my goal at every PCA Club Race is to improve by best lap time by one second. The key in racing is lap time consistency, meaning that you have to be as fast as possible in every corner, on every straight, in every lap, in every session on track. So my *achievement* over the weekend was having consistent lap times (except for Practice 3/Qualifying). See Figure 1.

I am a petite woman (about 95 lbs), so I thought I would have a huge

advantage over my fellow racers. However, I weighed my car after the race. I must be *obese* or something because my car is 150 lbs over minimum weight (including driver) permitted in our rules. Power-to-weight ratio is critical to achieve best cornering and braking performance. So, I have to shave some weight to help get that one second!

I would like to take this opportunity to thank everyone on the 2016 Can/Am Challenge Club Race committee, PCA stewards and volunteers who have participated in the event. Without you, we would not have had such an awesome club racing weekend. I was responsible for the club race budget and schedule for. We held our debrief meeting exactly one month after the race and started planning for 2017!

See the link below for a video made by the son of Roy Tam, a rookie racer last year. Roy received his PCA Club Racing license that weekend and his son, Ryan (and his school friends) made the video about Roy's first PCA club race:

<https://www.youtube.com/watch?v=ctPW2AOrsys> 📺

Figure 1  
Kathleen Wong, 2016 Can/Am Challenge Club Race at CTMP

Yellow Race Group	Class	Best Lap	Overall Position	Position in Class
Practice 1	F	1.44.4	23/36	
Practice 2	F	1.44.9	34/39	
Practice 3 / Qualifying	F	1.46.7 I probably ate too much at lunch!	36/39	
Yellow Sprint Race 1	F	1.44.0	28/40	7/10
Yellow Sprint Race 2	F	1.43.6	23/38	8/10

# 2017 PCA CLUB RACING SPONSORS



FOR INFORMATION REGARDING PCA CLUB RACING SPONSORSHIP  
CONTACT VU NGUYEN EXECUTIVEDIRECTOR@PCA.ORG 410.381.0924



[www.us.pirelli.com](http://www.us.pirelli.com)



866.325.5426  
[www.jx2pg.com](http://www.jx2pg.com)



704.799.3800  
<http://www.motec.com>



815.472.2939  
<http://lnengineering.com>



<http://toyotires.com>



866.201.1977  
[www.motioncontrolsuspension.com](http://www.motioncontrolsuspension.com)



773.286.5881  
[www.inglot.net](http://www.inglot.net)



800.722.3234  
[www.michelinman.com](http://www.michelinman.com)



Porsche Cars North America  
[www.porsche.com](http://www.porsche.com)



RACE FUELS  
800.722.3427  
[www.racegas.com](http://www.racegas.com)



865.200.4264  
<http://performanceoils.com>



877.TRAILEX  
[www.trailex.com](http://www.trailex.com)



843.524.8473  
[www.bobwoodmantires.com](http://www.bobwoodmantires.com)



info@softronicsoftware.com  
[www.softronicsoftware.com](http://www.softronicsoftware.com)



866.582.4957  
[locktonmotorsports.com](http://locktonmotorsports.com)



973.773.3177  
[www.stableenergies.com](http://www.stableenergies.com)



800.934.9122  
[www.ogracing.com](http://www.ogracing.com)



800.797.2911  
[www.gt-racing.com](http://www.gt-racing.com)



866.505.2739  
[www.apexperformance.net](http://www.apexperformance.net)



8704.450.4507  
[www.racetech-usa.com](http://www.racetech-usa.com)



800.542.0972  
[www.hawkperformance.com](http://www.hawkperformance.com)



512.273.5016  
<http://register.pca.org>



# Editorial License

SKIP CARTER • CLUB RACING NEWS EDITOR

## CLUB RACING IS OFF TO ANOTHER GREAT START

My wife, Suesan, and I attended the Sebring event (covered elsewhere in this issue). One of the things I enjoy about attending the year end banquet is hearing what the plans are for the upcoming year.

I got to see a little of RaceHero, the new timing system introduced at Sebring. T&S is getting feedback from drivers, but what I saw was impressive.

I also tagged along with scruts watching them do gear checks and borescope inspections. Pretty neat what technology can do

### West Coast Series

Suesan has taken over as the West Coast Series coordinator from Tom Brown. West Coast club racing generally does not turn out the numbers

we think we should, so this is our third year of actively promoting the program. Ten of the thirty-three 2017 club races are part of the West Coast Series. Participation has definitely been increasing, and we look forward to seeing more of the same.

With the writing I did elsewhere in this issue, I figured it was a good excuse for keeping this column short. 🍷

## DOES YOUR LIFE INSURER CHARGE YOU EXTRA FOR RACING?

MARC H. MILLER

CLU®, ChFC®, RIA®

OVER 30 YEARS OF EXPERIENCE  
INSURING OUR PEERS

LIFE & DISABILITY INSURANCE  
FOR CLUB RACERS & ENTHUSIASTS

120 BROADWAY, 37<sup>TH</sup> FLOOR | NEW YORK, NY 10271  
212.701.7979 MMILLER@STRATEGIESFORWEALTH.COM



Registered Representative and Financial Advisor of Park Avenue Securities LLC (PAS), 120 Broadway, 37<sup>th</sup> Floor New York, NY 10271, phone: 212.701.7900. Securities products and advisory services offered through PAS, member FINRA, SIPC. Financial Representative of The Guardian Life Insurance Company of America (Guardian), New York, NY. PAS is an indirect, wholly-owned subsidiary of Guardian. Strategies for Wealth is not an affiliate or subsidiary of PAS or Guardian. Guardian, its subsidiaries, agents, and employees do not provide tax, legal, or accounting advice. Consult your tax, legal, or accounting professional regarding your individual situation. 2017-37627 Exp. 3/19

# JX2

PERFORMANCE GROUP

## IS PROUD TO ANNOUNCE CONTINGENCY FOR ALL NON-SPECIFIED TIRE CLASSES IN PCA CLUB RACING.

### GO TO WWW.JX2PG.COM/CONTINGENCY FOR DETAILS.

JX2 Performance Group is proud to offer Pirelli tire sales, service and full team support at select PCA racing events.

Visit JX2pg.com or call 866.325.5426 before your next race.



Official Sponsor





# From Start to Finish

MICHAEL WINGFIELD • CHIEF OF TIMING & SCORING

## RaceHero — NEW LIVE TIMING/SCORING APP

This season Timing & Scoring is offering a new live timing and scoring application for mobile and computer devices – RaceHero.

RaceHero provides an enhanced live timing experience for our club racers, and it has a proven record with other racing organizations. Not only does the RaceHero application provide live results, it also retains results and personalized race data.

RaceHero offers the mobile application at no cost, with downloads available from both the Apple App Store and the Google Play site. Likewise, RaceHero offers a web version available at the RaceHero website.

I encourage you to visit the RaceHero website, look at the app they offer, and read their blog.

We made the RaceHero live timing system available for the first time in February at our first 2017 club race of the season - Sebring. With only drivers meeting announcements to let racers know we had an alternative live timing product, we offered the service and asked racers to use and evaluate the RaceHero application. The positive feedback I received from users of the application encourages me to provide the service to more races this year.

We will continue to provide the previous Race Monitor (<https://www.race-monitor.com/>) live timing in parallel with the new RaceHero live timing for part of this season. I en-

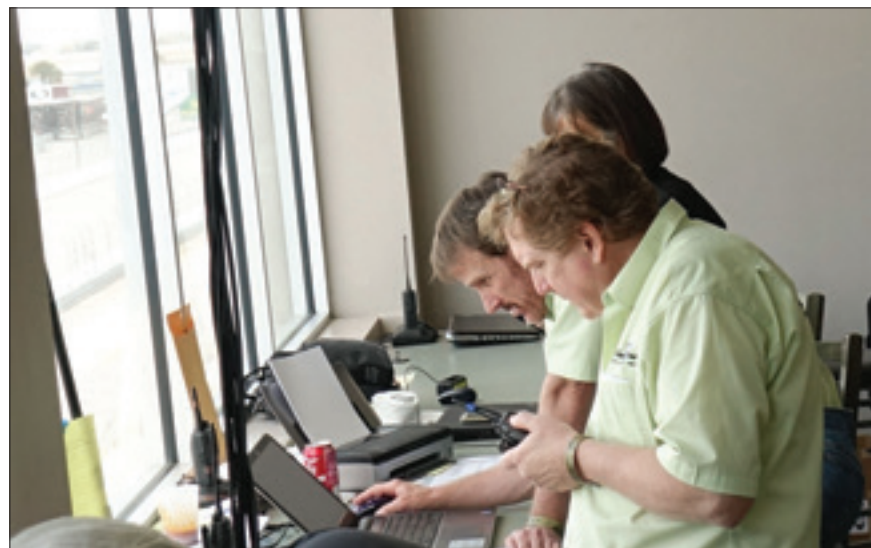

David Anderson (foreground) and Timing & Scoring Chief, Michael Wingfield (behind) in the tower at Sebring

courage you to compare each application in your own way and determine which you find preferable. I welcome your feedback. Our goal is to provide the most robust live timing solution for our racers.

You can download RaceHero from their website at: <https://racehero.io/>, or the mobile sites noted above. When searching for the mobile app, please note that there is no space between “race” and “hero” (it’s one word), otherwise you may find yourself loading a kid’s game. ☒



The new RaceHero monitor in Timing & Scoring at Sebring

**HUBstands<sup>TM</sup> PRO**  
PATENTED

Fully suspension compliant and height adjustable.  
Daytona winning ProHUBStands for the most precise, repeatable, wheels free hassle free set ups.

[www.HUBStands.com](http://www.HUBStands.com) 888.208.8570 [info@bbxracing.com](mailto:info@bbxracing.com)

Canada: [www.mantissport.ca](http://www.mantissport.ca) Europe: [www.bg-racing.co.uk](http://www.bg-racing.co.uk)

**WORLD**  
motorsports

Number one supplier of titanium lug nuts and bolts for Porsches.

- Largest Inventory of Porsche Titanium Wheel Nuts and Bolts
- Made to Porsche's Exact Seat Specifications for Premium Fit
- Extremely Lightweight and Strong
- Stay Looking New for a Lifetime
- Grade 5 (6AL4V) Titanium for Superior Strength
- Free Shipping when Ordered on our Website

Sales, Service and Installation. Custom Fabrication Services Available.

[world-motorsports.com](http://world-motorsports.com)  
2170 W. 190th Street Torrance, CA 90504 Phone: (310) 533-8900

Our Titanium Lugs are now approved for PCA club racing events.

HOME OF THE WIND TUNNEL  
**DYNO**



Franklin's #777 Cayman and the rest of the GTB1 field having their gears checked post race at Sebring by Walt Fricke

# THE LATEST ON COMPLIANCE TESTING

STORY BY FRANKLIN PRAY, NATIONAL SCRUTINEER

Some of us already had the experience of racing with one of the PCA Club Racing "black boxes" installed in the car over the past year. There are lots of myths around the type of data that is collected during compliance testing and what the scrutineers actually do with it and how it is analyzed, so let's spend some time to lift the veil behind this part of PCA Club Racing's compliance testing system.

Some people tend to forget that PCA Club Racing is an organization that relies on drivers self-certifying their car's compliance with the rules. This is done at the beginning of the race season with the Technical Safety and Annual Inspection Form where the driver certifies compliance of his car with the rules, and it happens

again when the driver registers at the beginning of a race weekend and signs his logbook, certifying that the car is in full compliance with the applicable class rules.

Along with random compliance safety checks and checks of weight, technical items, bore and stroke, gearing, borescoping of piston head profiles, and other inspections, PCA has instituted relatively sophisticated data acquisition procedures to sample various data to identify cars that have been misclassified, or those cars that require further inspections as their operating parameters are either inconsistent with specific class rules or show data parameters that are inconsistent with the data obtained from other cars in the same class.

## How do we obtain data?

The easiest and most straightforward way to obtain data is to plug into the owner's own AIM Systems and/or Smartycam data. We have also plugged into the owner's MoTeC Systems to check Cup Car gearing for example. This is usually done by directing cars coming off track to the Tech/Impound area, where we will plug in the PCA laptop to obtain the data. Rest assured that the Scrutineer downloading the data will not delete the data from your system.

PCA also has several custom built AIM EVO 4 Systems that get installed on the door roll bar on the passenger side of a car. The associated GPS antenna is magnetic and usually attaches to the front right fender.

The only connection that needs to be made is to the car's OBD port, which is usually on the lower part of the dash on the driver side. We usually make that connection by routing the wiring behind the driver seat so no part of the system impedes with the driver's operation of the car.

We also carry AIM Solo DL systems in our arsenal. Those systems are installed with a suction mount on the windshield close to the A pillar to the left of the dash and will then be connected to the OBD port on the lower part of the dash.



These installations can be done relatively quickly, whether on grid or during the mandatory five minute pit stop during an Enduro race.

## What do we do with the data?

The primary data we obtain is focused on four distinct areas:

### Boost Pressures

Through an additional pressure sensor that gets plumbed into the car's vacuum system and is attached to the EVO 4 system, we routinely measure boost pressure on turbo charged cars and make sure that it does not exceed allowable limits and is within the stock boost profile.

### Gearing

Stock and Spec Classes require stock gearing to stay in place. Through an extensive database of gearing, wheel diameters and tire sizes, we are able to check the relationship between engine RPMs and GPS speed and whether the gearing complies with class requirements. We will usually take data points from areas of the track where cars experience minimum longitudinal and lateral g loading, and account for tire diameter changes due to speed and loading.

Chart 1 shows speed (top) and

RPM (bottom) data detail from several cars in one class at Road America between Turn 3 and Turn 5. The outlier is clearly shown in RED. Even though this car seems to have the lowest min speed in Turn 3, shorter than stock gearing allowed it to closely match the top speed of the other cars into Turn 5. This car also seems to have a higher rev limit than the others, however increased rev limits are allowed in this class.

### RPM Limits

Stock and Spec Classes require for stock rev limits to be maintained. From the RPM data obtained, we are able to judge whether RPM limits have been illegally raised through ECU flashing, chips or other mechanical means. It is important to note that we will only use data obtained during upshifts, as many racers seem to routinely cause mechanical over-revs due to premature clutch releases during downshifts. In most classes RPM limits can only be raised by flashing the ECU, which is not allowed to be flashed in Stock and Spec Classes. Increased RPM limits are therefore also a good indication that the ECU might be illegally flashed, which will then call for additional scrutiny on that particular car.

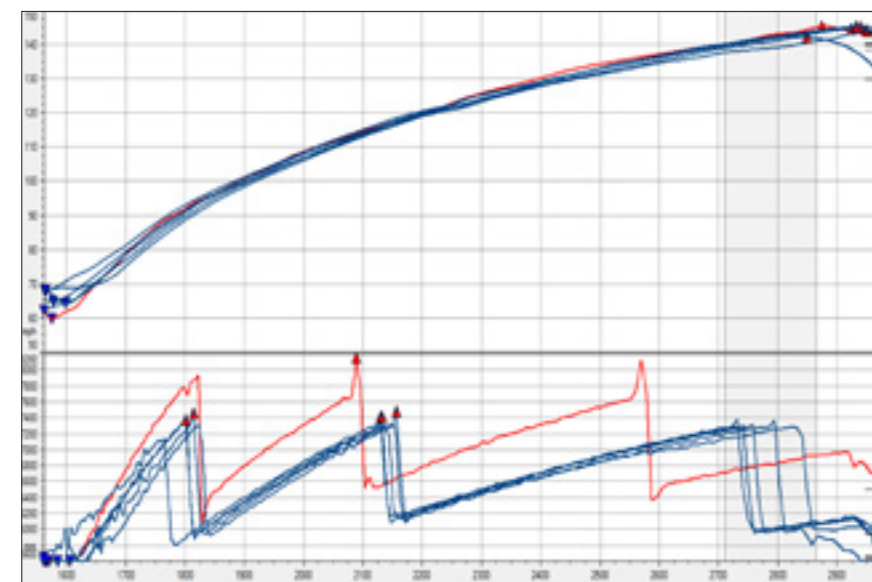

Chart 1: Speed (Top) vs. RPM (Bottom) indicating shorter than stock gearing for the car in Red

Chart 2 shows speed (top) and RPM (bottom) data detail from several 3.2 911 Carreras at Road America between Turns 3 and 5. The allowable 3.2 Carrera rev limit is 6520 +/- 50, which puts several of the cars clearly above the allowable limit.

#### Acceleration Curves

We will routinely look at acceleration curves on a comparative basis to identify outliers that call for further mechanical compliance checking. When looking at these curves, we will carefully take into account corner minimum speeds and the point at which the racer reaches the full throttle point (we can read throttle pedal angles) when accelerating out of a corner.

Many times we will get complaints from racers that a competitor's car "just pulls away". When we then look at the data, often times it is simply a matter of earlier full throttle application that provides that advantage. Chart 3 illustrates this situation, showing speed (top) and throttle position (bottom) data detail for Turns 4 - 7 at Sebring International Raceway with the RED car showing much earlier throttle application (noted in the chart) and therefore better acceleration out of these corners.

During the previous season, many Club Racers called for an increased level of compliance checking in order to assure a level racing "playing field", so we have additional resources and volunteers coming into the system for the 2017 season to assure that cars are classed correctly.

Keep in mind that scrutineers are mostly fellow racers, and remember that they are volunteers who have given up a weekend where they would otherwise be racing themselves (this is actually the hardest part of scrutineering). Please help them do their job by making it easy for them to do their job: All cars (other than GT1 - 6 and GTP classes) must have provisions for use of the PCA compliance testing equipment.

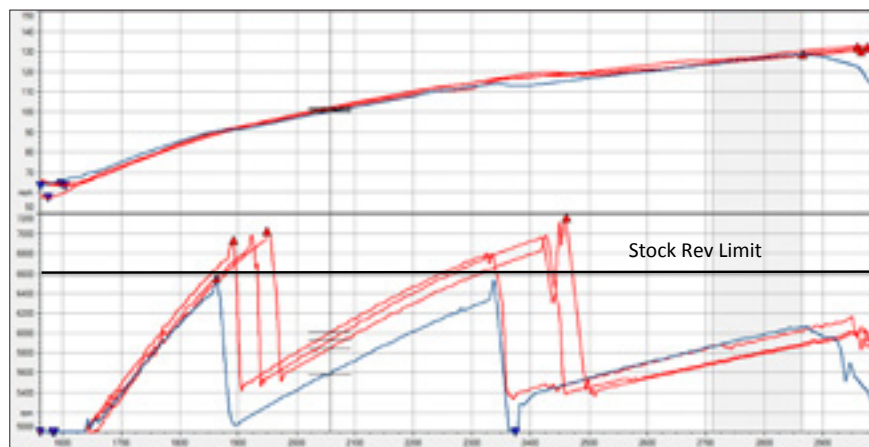

Chart 2: Speed (Top) vs. RPM (Bottom) indicating cars in Red exceeding stock rev limits

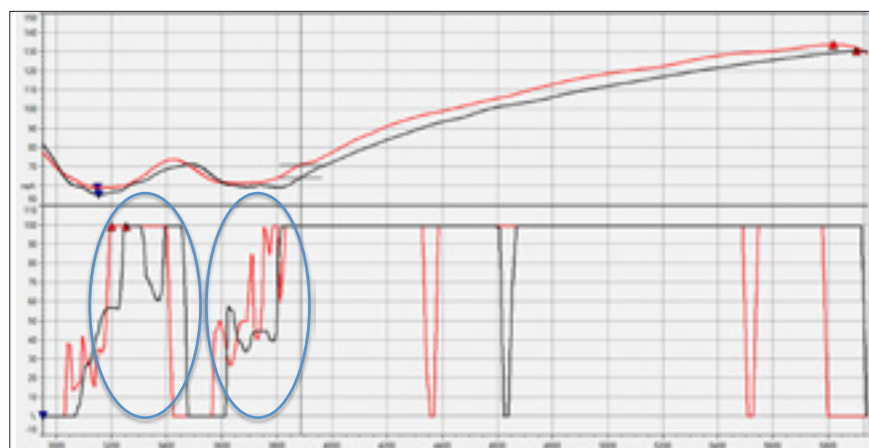

Chart 3: Speed (Top) vs. ThrottlePosition (Bottom) indicating an earlier commitment to throttle by the car in Red

1) Cars which came from the factory with OBD (the round 19-PIN port, or the trapezoidal 16 pin OBDII) must retain that port in an easily accessible location and with all of its wiring attached for use by the PCA compliance checking systems

2) Cars, which predate those ports, must have a connector with a 12V power, and a lead from the tachometer signal input terminal. The connector must be a flat four-pin trailer connector, located below the dash on the passenger side. The rule book has an illustration and the pin assignment for this connector.

3) When approached by scrutineers intending to plug into your own data system or install one of the

PCA systems, please allow them to do their job. Thank you!

As always, if you have any recommendations in terms of how we can improve what we do, I encourage you to make them. ☒



Franklin Pray

# HOLINGER

## AMERICA

### Transmission Solutions for Porsche Racing Cars

Holinger's own sequential gearkit conversion made for 911s was adopted by Porsche Motorsport and was the control transmission in every 997 "Cup" racecar they built. Now, the complete range of Holinger PCS spares and upgrades are available directly from Holinger. Why buy an imitation when you can buy the original?

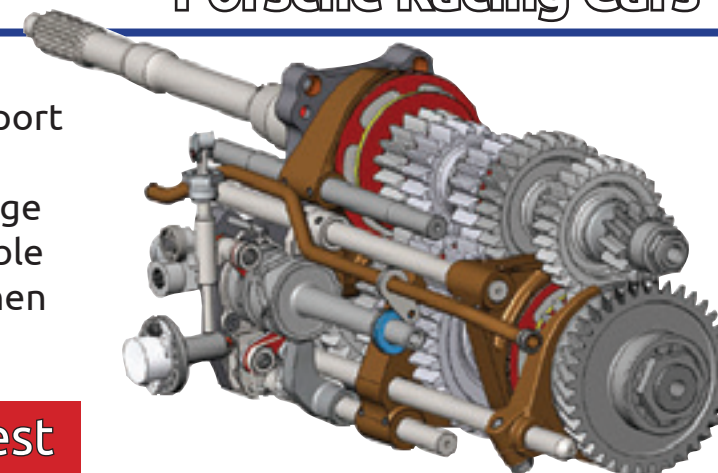

Contact us today to find your closest authorized dealer or expert installer:  
[info@holingeramerica.com](mailto:info@holingeramerica.com)  
 (949) 362-8750

**SPEEDSHIFT**  
 Plug and play  
 Paddle Shift kit for 997 Cup



#### HOLINGER Advanced Limited Slip

Available for:  
 • G50/G96  
 • 991 Cup

#### NEW from Holinger for 2017:

- Close Ratio 3-6 gearset for Cayman GT4
- Replacement gear program for 991 Cup

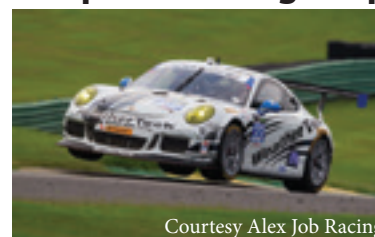

Courtesy Alex Job Racing





# Thinking About Rules

WALT FRICKE • TECHNICAL & RULES

## RULES, ENFORCEMENT, AND CHEATING

It is not uncommon for racers to wonder if some other car is faster because it has modifications not allowed by the rules. From the standpoint of a scrutineer, these issues boil down to whether a car does or does not comply with the rules which apply to its class and model. If a car is not compliant, is the driver a cheater? No one would think that if a seat belt was a year out of date. But what about engine size or gears?

We scruts can deal with most safety issues under a well formulated protocol. If the issue is outside that, we consult with the event steward, the captain of the ship at the event. For car performance issues with performance implications, we are like Sergeant Friday: "Just the facts." The steward decides whether a disqualification is in order, a change of class, or some other resolution, and whether to issue a 13/13 penalty. As scrutineers, at least we don't have to determine if the matter was willful cheating deserving of a 13.

A common refrain is that the car was purchased that way. No question, but sometimes the owner has no idea, as was the case with an E class Boxster that had the shorter transmission from the early 2.5 liter model. The previous owner had upgraded a 2.5 to a later engine, and neither the seller nor the purchaser realized that as Porsche increased engine power it also raised the gearing for fuel econ-

omy. Conversely (and coincidentally) at the same event, a Spec Boxster racer learned that the junkyard transmission he had installed was from the later model, and thus had the less favorable gears. All was resolved by the steward without lasting pain to the racers, as it was clear that these guys were not trying to get one up on everyone else. How many know how to see what gears are in a transmission, or what codes should be stamped into the transmission, even though compliance is the driver's responsibility? But these things are a steward's call.

### Altered Gearing

One of the most competitive classes, certainly in terms of car counts, is SPB. Naturally, there are dark suspicions from time to time about this or that car or driver. A 2.7 was discovered in an SPB based on driver assertions of pulling away on straights, and Frank Pray's article (elsewhere in this issue) shows how the AIM data found a car in another class with altered gearing, allowing it to compensate for the driver's lower cornering speed against his competition. He also notes where a different driver did better on the straight because he got off the brake earlier in the preceding corner and had better cornering speed. But, as often as not, checking some cars, including one under suspicion, turns up nothing amiss. Sev-

eral years ago the fretting was 996 Cups being rebuilt with 3.8s instead of the required 3.6. To date, no car has been found to have done that without registering in GTA1. There are some talented drivers in that class.

### More Resources Allocated

The Club Racing program has allocated more resources to this sort of technical compliance checking this year. It will behoove drivers to go over the rule book and their cars carefully. There are a lot of rules. While the easiest route to compliance in most cases is not to change what Porsche put on the car, many small things get overlooked. An example in SPB, for instance, is the *snorkel* found in the left side rear intake duct. Removal of this is not allowed by the SPB rules. It is easy to check (you just look into the duct for it), and we are enforcing this. In SPB, ballast may not exceed 75 pounds. Of this, only 25 pounds may be bolted to the passenger footwell floor (the most desirable place), and any of the remaining 50 pounds must be behind the driver's seat (where you don't really want it). Fudging on this must be quite a temptation for a light driver, but we have a portable scale and this is something we check.

Among the aspects of an SPB which can be checked is the valve job... Only three angle grinds (stock) are allowed, and we can see the seat

with a borescope. We can also look up into the exhaust port to see if it is some fancy shape. We can observe the rods with a borescope, and Pauters or Carillos are going to stand out like sore thumbs. The Woodruff keys for the cam can also be checked at an event to see if someone has used an offset key to change timing. While the implications for the driver may vary between fudging the engine and removing the snorkel, all this stuff gets checked, noted and, in most cases, involves an interview with the steward.

However, one way of looking at this might be how few blatant performance improving non-compliant modifications we find. One oversized crank in three years of checking. Of the over 50 SPBs whose gears have been checked, only one, to date, was found with a short 5th. That has to be quite a temptation, because Bryan Henderson tells me that at Watkins Glenn, at one point where you are at the rev limit in 4th, you slow down if you shift into 5th in a Spec Boxster.

At High Plains last year there was a flap about SPB headers. The rules do not allow substitution of Porsche stock parts, and examination of a number of these cars showed one whose header was slightly different, and the driver has long run up front. What's this? It turns out that at some point in the first Boxster model's reign Porsche made a slight change in how the two rear down tubes connect with the tube from the front cylinder, perhaps to gain some production efficiency. The tube lengths are the same, and dyno testing showed zero performance difference. Porsche has delivered crate motors with the older header on one side, and the newer on the other. So it is a Porsche '97-99 stock Boxster part, and no one should lust for the part either, or fret if a competitor has it.

We keep thinking of things to check on these cars, and ways to do it. Anyone with ideas on this score should share them with one or more of the scrutineers. It might be an area we hadn't thought about, and a feasi-

ble method exists for checking. We are keeping at it. Consideration has been given to having club owned ECUs with a stock flash and swapping them in and out of cars, especially with the data instrumentation installed. One scrut with the background to do it is looking into how we could just download a car's flash and examine suitable hexadecimal tables to look for anomalies. It would be great if we could do this because it would give us the flexibility to allow some changes (disabling the immobilizer, for instance) without letting the genie out of the bottle.

### NLA Cup Car parts

Enough on rules enforcement. As the Cup cars age, more and more parts specific to those cars become unavailable from Porsche. One of my tasks, on hearing of the NLA status of a part, is to approve a substitute. This involves checking with Porsche Motorsports North America to confirm NLA status, to see what PMNA uses as a substitute, to discuss the issue with shops which service these cars, and then publishing the approvals. If you have a Cup Car and use a shop, it would be good if you passed on these approvals as they happen. Not all shop owners or mechanics are licensed PCA Club Racers, so they don't necessarily get the e-mail updates Susan Shire sends out to all racers periodically along with information on upcoming events. And I am dependant on being told about the NLA status of various parts, so it is good for car owners and shop guys to know to contact me when they learn this or that part (for which the rules do not yet provide a substitute) is NLA. You never know just when this will happen. Witness below the fact that when Porsche made some changes to improve safety relative to the roll cage, they changed the 991.1 Cup tub with the introduction of the 4.0 liter 991.2 cars, but also discontinued production of the 991.1 tub. I learned this because a knowledgeable and conscientious shop asked me what to do about a customer's

wrecked 991.1 car. Listing these approvals in CRN may not be very timely, but it is a convenient place to memorialize them:

1) Some additional 996 Cup (GTC3) parts are no longer available from Porsche Motorsports. The following substitutions are allowed for this model:

- Headers, if damaged beyond repair, may be replaced with a) stock 996 GT3 or 997 Cup headers, modified to mate with an allowed exhaust system after the collector, or b) a fabricated replica of the same tube OD and ID and shape as the original Cup part made of mild steel or stainless.
- If the bushings are worn out in the shifter console, bushings of any material may be fabricated to replace the original bushings, or the Function First Shift Right 996 retrofit kit may be installed. This allowance may not include a "short shift" function.
- Shift cables are free as long as they are of stock length.
- The urethane front bumper may be replaced with an accurate fiberglass or flexible material replica (note - this does not allow use of carbon fiber).

2) The 2010-2013 997 Cup (GTC5) tubs are NLA, and modified 2006-2009 (GTC4) tubs may be substituted.

3) The 2014-2016 991 Cup (GTC6) tubs are no longer available. Modified 2017 Cup (GTC7) tubs may be substituted.

By the time you read this June 1 may have come and gone. That is the end of the rules proposal submission period. Keep looking on your e-mail for the July 15 notice, which is the deadline the rules committee has imposed upon itself for publishing potential changes for informed racer comment. ❏



# PCA CLUB RACING A FATHER'S PERSPECTIVE

STORY & PHOTOS BY PETER BUSALACCHI

Do you ever wonder, “How did we get to this point?” If you’re anything like me, you’ve said it several times (never out loud, however). It all started in 2002 when my daughter, Isabella, and I started racing 2-stroke go-karts. Isabella was in the 50cc powered kart and I was in a 125cc Rotax Max. We spent a great three years of racing and family time at the track.

During this period Amago Raceway in Northern San Diego County, and Cajon Speedway, in El Cajon, were our home tracks, so friends and family could come out for the day,

BBQ and watch Isabella, myself and my brother Tom, who bought a Rotax at the same time I did.

Isabella won her first race only four races into her first season. In her 2nd and 3rd seasons she had won more races in her class than anyone else. After moving up to the 80cc class, it was obvious that it was time to sell my kart and concentrate on her — she showed so much promise.

Three club championships later she moved up again to the 100cc class and dominated that category. Isabella went on to race in regional races at Fontana and Perris, California along

with her home races in San Diego.

In 2012 she entered a Sodi Sprint Cup series, a global competition where the best racers from each country compete in the World Finals in Paris, France each year.

Isabella was not an automatic qualifier, but was included as a “wildcard” entry, representing the United States along with two other racers. The opportunity of going all the way to France to compete was incredible, but the cost to do so was somewhat prohibitive. Thankfully, Isabella has grown up in the BMWCCA and PCA world, and through fundraising



from both clubs, we were able to fund her way to the Grand Finals.

For her first time at a new track, Isabella did incredibly well competing against 76 of the best racers from around the world and finished 15th overall in the Sodi World Championship final standings (both male and female competitors), top American racer and finished as the Sodi Female Sprint Cup World Champion!

In 2013, she was an automatic qualifier, returning to France to finish 16th in the world rankings for combined male and female racers, top American and won her 2nd back to back Sodi Female Sprint Cup World Championship!

It was at this time that I bought an old 944 Spec car, knowing that it would be at least two years before she could race it. The plan was for me to race the car, work on set-up, then hand it over to Isabella once she turned 16. The car was a nightmare in terms of reliability. We spent countless hours and money chasing and changing everything on the car. Not only was money running out, but so was my patience, as I must have sworn the car was going up for sale at least a dozen times.

Fast forward about six months and, after racing the car in PCA, POC and NASA (and winning in each series) it was time to hand the keys over to the eager teenager.

The first thing we did was go with a new livery. Some of you may remember the old Lancia Stratos from the early 1970s. I was just a young boy when that car competed in rally races, but it was the coolest thing I had ever seen at the time and thought, “why not?” We proceeded to transform the looks of the car to a sparkling white with large green and red vinyl stripes in the Alitalia sponsored livery. The car is a real head turner with looks, camera flashes and questions aplenty from many racers and spectators alike.

Because PCA doesn’t allow anyone under 18 years old to compete on big tracks, Isabella got her feet wet in the 944 Spec race car at PCA and BMW



autocrosses and at big tracks with POC time trials. She also started to compete at various tracks with Red Line Time Attacks in a 996 GT3.

She finally turned 18 and started competing in San Diego region and Zone 8 time trials, doing very well in her class, finally getting enough experience to apply for her PCA Club Racing license.

The 2016 California Festival of Speed at Fontana, California was her first PCA Club Race. She had never run the full roval road course and, throw in that it rained all weekend, it made her first PCA Club Race interesting.

Given that I've been her race coach since she was five, my words to her going into the weekend were: "I don't expect for you to be at the front of the grid for your first sprint race or the enduro, but those two races, especially the enduro, should give you enough time to learn the track and be very competitive in the two sprint races on Sunday".

Sure enough, Isabella was very cautious in wet conditions in her first race, finishing mid pack and doing the same in the 90 minute enduro. We worked with set up all day on Friday and Saturday to dial in the car to her driving style. By Sunday we knew that she would be ready to compete at the pointy end of the grid.

Saturday's finish sets the grid for Sunday's Sprint Race 2. Isabella started 8th. From the time the green flag dropped you could see that she was no longer being cautious and was now on the attack, passing competitors left and right. Once she made it to 3rd she found it a little more difficult and started to work on the 2nd place car. Isabella rode his bumper for about two laps until she pressured him into a mistake when he locked up going into the hairpin and she went underneath and started to catch the 1st place car before running out of laps.

In the Sprint Race 3, she was 2nd the entire race until the rain started to come down and, discretion being the better part of valor, slowed her



made to win

**PUMA AVANTI**  
FIA APPROVED (8856-2000) | SFI/5 APPROVED

The new PUMA Avanti suit utilizes revolutionary and proprietary advancements in material, form, function and design synthesizing the ultimate drivers environment for performance and endurance for the professional driver. Lightweight and breathable quilting of a unique 3-layer design consisting of an Aramidic outer layer, a Nomex waffle inner layer, and PUMA's new proprietary 'middle layer' offers an unmatched 33% weight reduction, an increase in permeability (breathability) by 55%, and a higher thermal protection by 11% over other manufacture's 3-layer lightweight designs. Anatomically correct pre-shaped body creating less bulk in the driving position, increased freedom of movement and agility, along with pre-shaped 'slim-fit' sleeves and pre-shaped legs reducing driver's fatigue of the arms and legs. PUMA's own proprietary EMS system of elasticized panels at the back of the arms, replacing soft knit gussets, reduces the weight and bulk in the shoulder area optimizing the acceptance of Hans head and shoulder restraints.

**FRONT**

**REAR**

Choose from black/white/red, red/black/white, blue/black/white, white/black/red, and grey/black/white.

**SL TECH MID PRO**  
FIA 8856-2000 APPROVED | SFI 3.3/5

**PODIO GLOVE**  
FIA APPROVED (8856-2000)

Authorized Centers	
Air Power Racing   UT   801-475-9380	Spring Mountain Motorsports   NV   775-727-6363
Driver's Edge Autosport   BC   604-298-5531	Track First   OH   234-380-5978
Framor Safety   MX   (52)555276-0558	Wine Country Motor Sports   CA   707-935-7223
Performance Speed Tech   TX   817-512-4780	Wine Country Motor Sports   CO   303-799-6606
	Wine Country Motor Sports   FL   561-748-5328

To find a dealer near you: **(714) 847-1501**  
or find us on the web at: [puma.subesports.com](http://puma.subesports.com)

Subé Sports is the exclusive distributor of PUMA Motorsports products in the USA.  
[www.subesports.com](http://www.subesports.com)



pace to bring the car home and eventually finished 3rd for another podium spot.

In May she raced in her 2nd Club Race at Willow Springs. She was locked in battle with her PCA Club Racing mentor, Chuck Sharp, and another racer from Las Vegas, Tim Meyer. All three were nose to tail from flag to flag in ALL THREE SPRINT RACES. She won Sprint Race 1, finished 2nd in Sprint 2 and was just a tenth of a second off the track record in Sprint Race 3 when the tires went away and she finished 3rd. All in all, a great weekend where she not only showed her speed, but incredible race craft in the way she managed traffic and put on passes into Turn 9 and over / under moves into Turn 1.

Her final race weekend before the long summer break was at Button-willow in late May. She continued to show her pace and race craft by qualifying on pole for all three races and winning all three of the weekend's sprint races. At the time of this writing, she sat in 1st place in the Western Region 944 Cup standings and 2nd nationally.

Isabella will start her college classes again in August (2016).

Coupled with her part time job with fellow PCA racer Roland Schmidt, she will only have time to compete in one PCA club race in November the rest of the way in 2016, but it's been a great rookie year thus far and she hopes to complete in more races in 2017. 🏁

**CupCar Solutions** Porsche® Cup Car related products and services

**New Cayman Air Jack Retro-fit Kits Available Now**  
Complete with hose, fittings, air jacks and air lance

Mounting tubes/gusset plates also available

**KRONTEC SUBEK STÄUBLI**

4421 Wild Turkey Way | Gainesville, GA 30506 | 404-992-0809 | jackgilsdorf@mac.com | www.cupcarsolutions.com

**Bosch Motorsport MS3 Sport ECU**  
Programmable Engine Management for GT3 Cup

**Bosch Motorsport M4 Clubsport ABS**  
Affordable Motorsport ABS System using the same M4 Control Unit with universal wiring loom

**BOSCH**  
Bosch Motorsport  
Authorized Dealer

**AUTOMETRICS**  
motorsports

108 Podiums  
45 Wins  
10 Track Records  
2 National Championships  
2016 PCA Club Racing

Now a Bosch Motorsport Authorized Dealer

843.763.7356  
autometricsmotorsports.com

**MCS**  
MOTION CONTROL SUSPENSION  
MCS Authorized Dealer



Isabella on the kart track at six years old holding hands with her dad (upper right)

Isabella with Jean Eric Vergne, Toro Rosso F1 driver at the time (middle left)

Isabella and her dad, Peter with their Alitalia livered SP1 car (middle right)

Isabella at her first Formula 1 race, Indianapolis. (lower left)



Be Smart, Not Sorry

Winners Do The Research



**FORGELINE**

CUSTOM BUILT • LIGHTWEIGHT • FORGED ALLOY WHEELS

800-886-0093

WWW.FORGELINE.COM

AMERICAN DESIGNED AMERICAN MADE

# PASSING OUT ON OR SOON AFTER LEAVING THE TRACK

A STUDY INVESTIGATING OXIDATIVE STRESS

STORY BY PAUL GUTOWSKI MD, PCA CLUB RACING MEDICAL COMMITTEE

I suppose that most of us have exited our car after a track session and experienced various degrees of exhaustion and fatigue. My wife, Kim, came very close to *passing out* on two separate occasions, first at The Glen and then Sebring, on very warm days.

We lost a Colorado icon and friend with the passing of Jerry Schouten at High Plains Raceway in 2013. I think that we all believe that driving on the track produces significant physiological stress, but how can we prove that?

A search of current medical literature shows very little research in this area. A 2006 study suggested physiological and cardiovascular stress; more recent studies have shown increased body temperature and heart rate. I'm a trauma physician at St. Anthony's hospital in Lakewood, Colorado, a busy Level 1 Trauma facility and home of the first helicopter service in the country (Flight for Life, 1972), and recently we've been investigating reduction/oxidation reactions in trauma patients.

We were able to design and obtain approval for a study investigating Oxidative Stress, which we completed at the High Plains club race in Deer Trail, Colorado, September 9-11, 2016. The formal article has been submitted for publication in The Journal for Sports Science.

We had 26 male racers volunteer for the study (women were excluded as that group would not reach statistical significance). Twenty-three completed the study. A questionnaire was completed prior to taking to the track on Friday. Blood was drawn, blood pressure, heart rate and body temperature were measured. The same

was done within one hour of exiting the track after the third session on Saturday, the unofficial qualifying session when we felt all would be under full stress, but to then allow the participants to focus on their upcoming races.

Here's some biochemistry: the reduction/oxidation (redox) system is active in controlling the balance between the production and use of free radicals and their mitigation by antioxidants—a push/pull system. Free radicals are necessary for vascular tone, immune responses, wound healing and other physiologic responsibilities, and an imbalance in their favor can result in damage to proteins, lipids and DNA. This is called *Oxidative Stress* and may lead to cardiovascular and neurologic disorders.

With recent developments in technology, we were able to bring a redox analyzer to the track and measure Oxidation Reduction Potentials (ORPs) and antioxidant capacity on site. There is strong evidence to correlate oxidative stress with elevated ORPs. At our hospital we have published articles showing that these ORPs - the oxidative stress - is doubled in trauma patients with multiple injuries. Other studies have shown elevated ORPs in marathon runners and basketball players over a season.

## Results comparing pre- and post - driving:

Oxidative Stress: there was a 14.6% increase in ORP values. Cooling shirts: no change in ORP, heart rate, blood pressure or body temperature. Blood pressure: no significant change. Body temperature and heart rate: in-

creased. There were several other interesting findings.

Higher body weight, higher initial blood pressure and lower antioxidant capacity correlated with higher post driving Oxidative Stress (ORP values). All drivers with high blood pressure were taking medicine to treat that, and while these drivers had the same elevation in ORP values, were overall lower pre- and post- (we suspect that it was the blood pressure medicine, not the high blood pressure itself, that lowered the ORP values). Vitamin use indicated a small decrease in ORP values, and did show higher antioxidant capacity.

This is the first study of its kind and we greatly appreciate the racers who participated. There were two limitations which should be mentioned. The number of subjects was small however, all measurements reached statistical significance and therefore, we were able to submit for publication. The other factor was that this was a cool weekend on the plains of Colorado, and cockpit temperatures were measured in the range of 22-37 degrees Celsius (71-98 F). A 2014 study of race cars measured a high of 66 C (150 F). This might have limited the elevation of several of our study values, and may have been a contributor to the lack of benefit of cooling shirts.

This study is the first to report that oxidative stress increases after engaging in high speed automobile racing. Our hope is that it will become a building block to future studies to learn more about the physiological stress we place on ourselves and develop methods to minimize this risk. ☑

# ACCESSPORT TUNED

## World Fastest Turbo S

EKanooRacing



1/4 Mile Record 9.397 @ 146MPH

## 1st Place - Time Attack 2

Porsche of Colorado Springs



2015 Pikes Peak International Hill Climb

Predator Performance

## World Fastest 991 TURBO



1/2 Mile Record @ 177MPH

## World Fastest Turbo S (Stock Turbo)

Vengeance Racing

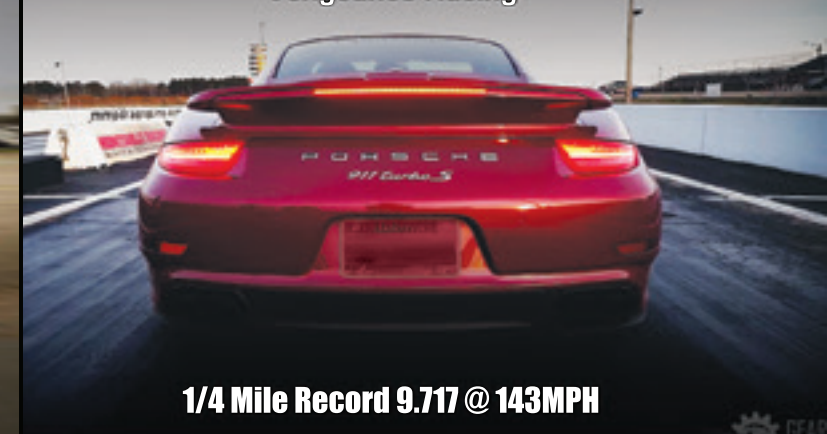

1/4 Mile Record 9.717 @ 143MPH

## ACCESSPORT

THE COBB ACCESSPORT V3 FOR PORSCHE  
981 | 987.2 | 991 | 997.2 | 997.1 | 996

Easy handheld DME/ECU flashing anywhere, anytime. Live engine parameter feedback and datalogging. Free, pre-programmed maps for common modifications. Fully featured custom tuning software for any modification level. The only engine management system you will ever need.



COBB  
PLANO

COBB  
SURGELINE

COBB  
SOCAL

[www.cobbtuning.com/porsche](http://www.cobbtuning.com/porsche)

COBB



PCA Club Racing co-chairs Bryan Henderson and Vicki Earnshaw with 48 Hours of Sebring co-chairs Dan Smithyman and Josh Breckeen at Thursday staff meeting/lunch

## FRIEDMAN SPIRIT AWARD GETS ITS START AT SEBRING

STORY BY DAN SMITHYMAN - PHOTOS BY STEVE RASHBAUM AND SKIP CARTER

The 2017 version of the annual Sebring Club Race was special in many ways. For me personally it was like no other. Much to my surprise, I was presented with the first annual Alan Friedman Spirit Award for my contribution to the 48 Hours at Sebring over the years.

To say that I was shocked and humbled is an understatement. Let me tell you, if I would have known that this was going to happen, I would have gotten a fresh haircut!

Now, as it happens, the 24th running of the Club Race at Sebring was my 10th year as co-chairman. I have been hanging around for a while.

Starting in the late '90s and early 2000s, I enjoyed my first few years at the event as *just a driver*. In 2003, when I accepted the office as DE Chairman for the Gold Coast region, I came to be the keeper of the track radios. This position apparently included an appointment to the 48HRS Committee as "communications officer..." Who knew?

For the next few years, being on the committee was an honor, and really easy. All I had to do was show up, charge up, hand out the radios... then drive all weekend. Nice! Let me say that this position in no way prepared me for my next committee job.

One dark and stormy night I got the call. The president of PCA national and the club racing big wigs were calling. They said they felt that the presidents of the two host regions should be co-chairs of the Sebring event. At that time I was president of the Gold Coast region, and my buddy, Dave Herndon, was president of the Suncoast region. Both of us had been on the committee for years.

On the committee? Yes (that is one thing)... But co-chair? Oh sure. I hung out in the truck with former co-chair Don Busby timing pit stops the one year when the timing loop crashed. And, of course, I watched

EBS Racing is your  
**MAHLE motorsport**  
Preferred Dealer!

**MAHLE**  
motorsport  
Master Distributor

A shipment of **Porsche Mahle Motorsport Pistons** has just arrived.  
Call or email for current price and availability!

Set Number	Description
PS80-001	PORSCHE 911S 2.0L 9.5:1
PS84-001	PORSCHE 911S 2.2/2.4L (2.2 9.3:1CR 2.4 9.5:1CR)
PS86-002	PORSCHE 911S 2.5L 10.3:1
PS98-005	PORSCHE 911 3.0-3.2 CIS 9.8:1 (Wedge Dome Max Moritz Style)
PS98-009	PORSCHE 930 TURBO 3.4L 7.5:1 (3.3-3.4)
PS98-010	PORSCHE CARRERA 3.2-3.4L 9.8:1 (3.2- 3.4 Motronic inj.)
PS102-017	PORSCHE 964 NA 3.8L 12.3:1 (107mm slip-in cyl 3.6-3.8)
PS102-018	PORSCHE 964 NA 3.8L 12.3:1 (bore in 109mm cyl 3.6-3.8)
PS102-019	PORSCHE 993 TWINTURBO 3.8L 8:1 (109mm bore in cyl 3.6 TO 3.8)
PS102-020	PORSCHE 993T 3.8L 8.5:1 PP102- 013 (107mm slip-in cyl 3.6-3.8 NA to Turbo conversion)
PS102-021	PORSCHE 993T 3.8L 8.5:1 PP102-01 (109mm cyl bore in 3.6 TO 3.8)
PS102-02	MMS 993 RSR 3.6L 11.4:1 (107mm slip in cyl 3.6 TO 3.8)
PS102-023	MMS 993 RSR 3.6L 11.4:1 (109mm bore in cyl 3.6 TO 3.8)
996 103 915 3.8 MA	PORSCHE 996TT 3.8 liter (102mm 23mm pin 9.4:1CR 3.6-3.8)
996 103 942 3.8 MA	PORSCHE 996 GT3 3.8 late (102mm 21mm pin 12:1CR 3.6-3.8)
996 103 942 4.0 MA	PORSCHE 996 GT3 4.0 late (105.4mm 21mm pin 12:1CR 3.6-4.0)
997 103 915 3.8 MA	PORSCHE 997TT 3.8 liter (102mm 23mm pin 9.4:1CR 3.6-3.8)
997 103 938 91 MAH	PORSCHE 997 GT3 (102.7mm 21mm pin 12:1CR 3.6-3.8)

### Need piston rings?

Call or email with application, thickness, and ring diameter for a price quote.

### Have a custom application or need a piston set not listed?

Call or email with details. We can have your custom piston made to your specs by Mahle Motorsport, Je Pistons or CP Pistons.

### Need a single piston or cylinder?

Call or email for price and availability.

## Join Team EBS Racing

**Dealers and customers:** join Team EBS Racing to receive our newsletter filled with new product releases, tech info, photos, videos and more. Sign up this month and receive a free pdf copy of the 2016 Porsche Cayman GT4 Technik Introduction. **Sign up at [www.ebsracing.com](http://www.ebsracing.com).**



**EBSracing.com**

email [ebsracing@aol.com](mailto:ebsracing@aol.com)

toll-free **800-462-3774**

international **775-673-1300**

international fax **775-673-2088**

4068 S. McCarran Blvd. | Unit B | Reno, Nevada 89502

closely as my friend, Gold Coast co-chair Dave Tabony, rode regally around the paddock in a golf cart with that cool hat on. I was pretty sure I could do that!

But me, chairman? I don't think so. I said "no thank you" more than once. With six months to go before the event, they hadn't given up. It became apparent that Dave and I were going to co-chair one of the largest PCA club races in America, I was unsure, at best.

The guys from national were convinced that this was a good idea. With 300 or so Porsche Club of America drivers coming from all over the country, a few pro race teams bringing the big buck cars, trucks and drivers... And two rookie chairmen. What could possibly go wrong?

The one thing that made me think that we had any chance of averting total disaster was the committee. Ah yes, the amazing 48 Hours Committee. The committee is made up of a couple of dozen dedicated folks, all of whom have at least a few years at their respective positions. All know their jobs well and all have a major commitment to the event.

Several of these amazing people have been on the 48Hours Committee much longer than I, some since the very beginning. One by one the committee members gave us their pledge of support, which meant a lot.

### It all became fun for me...

It all became fun for me the day I realized the truth. The truth was that I didn't need to know everything about Club Racing. I just had to know who was supposed to know! "Umm, hey there Dan. I need to switch from the pink enduro to the black enduro and I was wondering about the eligibility of my co-driver." A very short time ago I would have responded: "Huh?". But I now knew the formula! "Ah yes, that is a question for Nick. He is right over here." "Hi there, we are here from Wisconsin as volunteers and don't know what to do." "Well then" was my enthusiastic response, "welcome to



Vicki Earnshaw presenting the Friedman Spirit Award to Dan Smithyman at the Thursday night Awards Banquet

Florida! Jerry Daily is over in registration and he can get you started. Climb on the golf cart and I will take you there." Wow, the formula was working well! Now I just needed a t-shirt!!! "I might not know, but I know who knows!" My ability to delegate and trust my team became legendary.

For the past ten years I have done exactly that, create space for some very talented folks to do what they do and be who they are. The magic of the 48Hours at Sebring is that it is a con-

certo produced by a group of unique individuals working together as one.

And so, it is on behalf of my colleagues on the 48Hours at Sebring Club Race Committee that I humbly accept the Friedman Spirit Award. Thank you I and I hope to see you again next year.

Dan Smithyman  
Co-Chairman  
48Hours at Sebring  
PCA Club Race



# CARQUIP

Porsche Parts & Transmission Specialists

Contact us at: [email@carquip.com](mailto:email@carquip.com)

**Transmission Sales & Build-to-Order**  
741, 901, 911/914, 915, 930, G50, G64

- Full Service Factory Spec Rebuilds
- Full Service Race Charts & Builds
- Custom V-8 Conversion Specialists "Tips"
- Custom Off-Road, AutoX, Hillclimb, Rally, & Road Race
- Largest Inventory of NOS, New, Used Transmission Parts in the Country
- We also buy good used and core transmissions

**CUSTOM MANUFACTURING OF THE FOLLOWING:**

- Twin Plug Distributors (2.0L - 3.6L)
- Aircraft Quality Gears (741 - G50)
- Special Ratio R & P's (741, 911, 915, 930, G50)
- 915 Stainless Bearing Retaining Plates
- ZF Type LSD's and Torque Bias Diff
- 911 Billet Aluminum Intermediate Plates
- 904 Mainshafts & 904 Special Ratio Gears
- 915 Mainshafts w/ Active 1st Gear
- Cryo treatment of Gears, Ring & Pinions, etc.

**WE ALSO BUY & SELL PORSCHE'S !!**



[www.carquip.com](http://www.carquip.com)

7191 Arapahoe Ave - Boulder, CO. 80303

**303.443.1343**



## Driver Coaching and Development

"The biggest improvement to our program was Mike Zimicki!" Race winning IndyCar engineer

### Michael Zimicki

Building racers since 1981

Coaching first time drivers to IndyCar winners  
Individual and team coaching available  
Let's work together to find the speed within you!

Some successful clients:

Ryan Huner-Reay, Graham Rahal, Danica Patrick, Jon Fogarty, John Edwards and others

614.270.3141

[mfzcoach@yahoo.com](mailto:mfzcoach@yahoo.com)

[www.SlideRuleMotorSports.com](http://www.SlideRuleMotorSports.com)





# Coaching Perspective

DAVID MURRY • CLUB RACING DRIVING COACH

## WE DRIVE A LOT AND STILL CANNOT GET FASTER!

So, how do we improve as a driver? We drive a lot and still can't get faster? The key is to have the knowledge of *how* to go faster, then practice it. If we drive the same technique over and over, all we do is perfect a bad technique. You might drive that technique as perfect as it can be done; Vettel couldn't do it better. The problem is that that technique may only yield a lap time two seconds less than the car is capable of (if driven with the correct technique). There is no magic; physics dictates how fast a car can go through a corner. If you can drive the car optimally through the corner, no one can do it faster, not even Vettel. Physics are physics.

### Knowledge:

We need the knowledge on how to get the most driving our car. For that you need someone who already knows how. We can't do it ourselves because, if we knew how, we would practice it and execute. If we have been driving for a long time, we will need to be open minded to new ideas on how to get the most of it. Finding that person or venue to learn the proper techniques is sometimes challenging.

If we don't know the correct technique, how do we know who does? It's like picking a doctor: if we don't know medicine, how do we know our doctor is a good one?

The fortunate thing for racing or driving is that the competition will tell you who can at least execute and

be competitive as long as their equipment is. The other factor is — can they teach/coach? It's one thing to drive fast, but another to convey the technique to others. Get with someone that you can work with and communicate with. I think it's important to do this from the early days of track driving. You need to learn the correct technique from the start as you build muscle memory, which is very hard to change later. After you have perfected a bad technique, it's much harder to change.

One example is minimum speed. I have seen many drivers looking at their data acquisition focus on having the highest minimum speed in a corner not realizing that doesn't relate to lower lap times. If you drive a Miata with not much power in a high speed corner you might want a high minimum speed but most of the corners in most cars you want a lower minimum speed so you can turn the car toward the following straight and get on the gas. The time you lose in the corner you will more than make up on the following straight due to higher exit speed.

### Execution:

Now that we have the knowledge, it is time to execute (easier said than done). I drove some hot laps during a driving program alongside another instructor. He made some mistakes and, when we came in, I said "John, you know better than to do that" to



which he replied, "It's one thing to know and another to execute". I had a revelation when he said that. It would be like Eric Clapton showing me how to play a great song on the guitar. When I botched it trying to play it he would have said "David, you know better than to do that." That's why, after we gain the knowledge of how to drive the correct, the technique, we need to practice it.

When we practice trying to learn a technique and change muscle memory, we may need to slow down to safely work until we master the technique. Our lap times will be slower for a while, but with the new technique we will eventually be faster than ever, and safer, since we are driving by physics and being proactive, not reactive, to what the car is going to do. 🏁

Porsche of Conshohocken presents...

# Riesentöter Stuttgart Challenge

at Monticello Motor Club

JULY 2017  
14-16



- World-Class Facilities
- 3.6 Mile Full Course
- 2 Sprint Races plus Fun Race
- 90 Minute Enduro
- GT4 Clubsport Group
- Vintage Racing Group
- Lots of Practice Time
- MMC Will Offer Thursday Test & Tune Day at New Lower Cost



Registration: <http://register.pca.org>  
opens May 29 at 10:00 PM ET.

Fri....Practice and Fun Race  
Sat ..Warm-Up, Qualifying & 2 Sprint Races  
Sun..Qualifying, Warm-Up & 90 Minute Enduro

Gourmet breakfast and lunch, Awards Dinner, craft beer and fine wine included.

Questions? E-Mail Chris Karras, Race Chair:  
[rtr-racechair@nazg.com](mailto:rtr-racechair@nazg.com)

## Also new this year... Vintage Racing!

- Dedicated Vintage Run Group
- 1983 or Earlier Air-Cooled

### Vintage Schedule Highlights

Fri....Practice and Fun Race  
Sat ..Warm-Up, Qualifying & 2 Sprint Races  
Sun.. Warm-Up & Sprint Race

Questions? Contact Fred Pfeiffer, Club Racing Vintage Coordinator. E-Mail or call:  
[fpfeiffer@atlanticbb.net](mailto:fpfeiffer@atlanticbb.net) or 301-707-9472



## Tap into the raw spirit of club racing...

New in 2017, the Riesentöter Stuttgart Challenge welcomes PCA Vintage racing to its fourth annual event at Monticello Motor Club...

PCA Vintage racing takes club racing back to its roots. Run your '83 and older air-cooled cars in a dedicated run group at America's premier private motorsports club.

Bring out your 356s and 912s as well as 914s, 914-6s and early 911s!

Ask those who participated in PCA's inaugural vintage club race and you'll find this is truly a "can't miss" opportunity!



Event, Hotel, and MMC Test Day Information:  
<http://tinyurl.com/rtrclubrace>



Larry Helm SP2 leads Jason Stanley SP1

# 11TH NATIONAL 944 CUP GOES TRANSCONTINENTAL

STORY BY PATTI MASCOE - PHOTOS BY STEPHEN KRUPNICK AND DAVE DERECOLA

## Highlights from the East Coast

As they say, a decade can go by in an excruciating 5,260,320 minutes, or in an exciting flash, depending on what you are doing and the people you are with. Looking back at the prior wall of 944 Cup national winners, the latter impression most certainly rings true.

It began in 2002 with an invitation from Dave Derecola to other owners of Porsche's aging, entry-level front engine coupes to race at Summit Point, West Virginia, with the simple promise of close, affordable racing.

Now in place for 14 years and serving as a model for other race series, the 944 Cup mission is to offer a

competitive grid, where racers can easily find one of these vintage sports cars, then rely on preparation, wits and skills to compete on a level playing field.

Yet with hindsight, it's not every pass or finish that is remembered. From first-place to last on the grid, win or lose, the people are remembered; the close friendships endure. From the gregarious youngster Brian Zalner, who won that first (North) 944 Cup championship 14 years ago to Jersey Joe Hrymack, who won three regional titles and a national cup in the early years, to the engaging Super Cup run of Frank Celenza and the generosity and four-time domi-

nance of Karl Poeltl, what a ride it has been.

After 15 laps at Daytona International Speedway, we can add two more names to this storied list of winners, representing the first-ever 944 Nationals East: Fred Beasley, Florida Crown region, in Cup, and Dennis (Denny) Hiffman, Chicago, for Super Cup. (A West National Championship was also introduced this season.)

Perhaps the fortunes for these two men were predicted at Road Atlanta in April, the second major event on the 2016 calendar. Never mind some difficult wet-dry conditions, Fred surged out of the gate fast on his way



Denny Hiffman, Dave Derecola, Vicki Earnshaw, Ed Dunne and Tom Collins



Fred Beasley, Cup champion in the 944 Nationals East series

to earn two Cup wins at the Georgia venue. In addition to this year's South 944 Cup regional championship, Fred's stellar "career" in the 1989 944 he calls "a workhorse," spans more than 50 wins and over 80 podiums.

Meanwhile, after clouting the wall with the yellow #141 (a 968 Firehawk) in practice, Denny was not content on the sidelines, so he jumped into the 951 S of fellow-racer Poeltl. Soon, the master short track and road course pilot overcame the hurdles presented by the new Super Cup machine and finished progressively better in each subsequent contest, the last of which was a top-five in the 90 minute enduro.

In the competitive Cup arena, Fred's strategy, all year long, was one of "staying at the sharp end of the race and driving hard every lap," he says, with emphasis on *every race*. Accordingly, the 16-year veteran of SCCA, PCA, and 944 Cup racing does not downplay the contributions of preparing both the car and oneself for competition.

The secret for Daytona's 3.5 mile road course-oval was aligning the car for straight-line speed, taping the body gaps for the best aerodynamics, and taking advantage of tire pressures. Inside the cockpit, being physically fit "definitely assists in these long race weekends."

When you have "the top three fastest competitors probably in the entire east coast" explains Fred, "I was nose to tail fighting for first and second most of the championship race." Joshua (Josh) Vieira, who

showed polesitter speed in both qualifying and regional sprint action, was disqualified from the national feature because of weight, while Nort Northam failed to start the race due to engine concerns. James Rothenberger slotted into the runner-up position behind the winning Florida native, after the Riesentoter driver repeated in North competition.

Even though Denny was comfortably back at the helm of his own Super Cup steed, a fourth-place qualifying run made the Chicago native seem far from home. Denny fell in behind Gary Collins, the Daytona lap record holder, and a super-fast Brian Weathered, a first-time Midwest regional winner this year. But sprint race times would determine the championship's starting grid.

And then again, Denny has put some significant gas in the tank over his career, including almost 40 class wins and over 125 podiums since 2005. Saving the race's fastest lap for last, Denny pulled out the national victory by four and 19 seconds over the podium finishers, Weathered and Edward Dunne, respectively.

Although the SP1 class, which features tight specifications for normally aspirated 944s and their tires, is more popular on the West Coast, a second South regional championship in a row was awarded to John Torgersen, a Coastal Empire region member, along with East honors nationally. (Jason Stanley won the spec outing, but was not eligible for the championship trophy.)

## Highlights from the Inaugural West Run-Offs

If you want some room to race, the state of Texas certainly has that covered. And if you want some parity when pursuing a regional or national title, the 944 Cup also has that covered. With the SP1 class you get uniform racecars: The approximately 150-horse-power engines are stock; tires are specified; fancy wings and spoilers are not allowed; and only certain suspension components can be installed before they are adjusted.

Put these two elements together and the result is one heck of a championship. Held at the MotorSport Ranch in Cresson, Texas, the first-ever 944 Nationals West put 10 racers in similarly equipped 944s on 11 turns, allowing them to duke it out on 40-foot-wide pavement – as open as any international raceway – to find out whose racing skills are the "best in the west." Since the racetrack conditions were literally dusty and smoky during the 18-lap run-off, it is not a cliché to say that when the dust settled, Jeffrey Wiggins, a 55-year old out of the Maverick region, came out on top.

Wiggins, a longtime 1981 911 pilot, proclaims, "For those of you who have never experienced an SP1: Driving under-horse-powered cars when surrounded by other under-horse-powered cars is fast." Yes, just before winning the West nationals in a 1987 944, Wiggins took home an overall PCA sprint victory at Road America in that vintage 911. In switching cockpits, the biggest ad-





justment the Maverick region member says, is recovering from an addiction to trail braking, something the 944 does not like. "At each track," he explains, we're always looking for ways to spend less time on the brake and more on the gas."

The competition was tight on the ranch after a split start separated Spec Boxsters from Spec 944s in multi-class PCA action. Drivers pushed the throttle, leaned into the brakes, and tossed the relatively soft suspensions side to side in efforts to gain an advantage. "Once the traffic arrives, Wiggins noted, "it's a game of chess... not always in one's favor." The eventual 944 Cup podium, which included Wiggins, Pat Heptig, and Philip Hanson, all traversed the 1.7-mile course, with best laps in the 1:26 range. The two runners up had the closest battle, with only 0.127 separating them at the finish. 🏁

We managed to get the entire 944 Cup group out to the grid early to take these group photos (top & bottom)

Fred Beasley



Dave Rodenroth and his SP2. Dave can also be seen at some tracks wearing the green shirt of a Club Racing steward



# DEMON SPEED MOTORSPORTS

HIGHLY ENGINEERED SOLUTIONS FOR YOUR PORSCHE MOTORSPORT NEEDS.

**TARETT ENGINEERING**  
Competition Suspension Components

**HAWK PERFORMANCE**

**NECKSGEN**  
AHEAD IN NECK PROTECTION

**JOE TOTH COMPOSITES**

Wing uprights 4" to roof height featuring custom colors and designs.  
Boxster/Cayman Splitters, Ducktails, Diffusers  
996 and 997 Double Height Jack Stands.  
Brake Pads and Rotors.  
CSF radiators.  
Helmets, belts, neck harness for all the personnel protection requirements.  
All Maintenance and Spare Parts in One Easy Stop.  
New and Used parts available.  
Custom Design and Build Solution

**Don't Just Get FAST.... Get Demon SPEED**  
(216) 333-1200 [demon-speedmotorsports.com](http://demon-speedmotorsports.com) [sales@demon-speedmotorsports.com](mailto:sales@demon-speedmotorsports.com)

## Zone 2 PCA Club Race

### "Rumble at the Oak Tree"

June 23 – 25, 2017

#### Virginia International Raceway

Alton, VA

The full course at VIR is recognized as one of the top race tracks in the country!

The format includes two Sprint Races on SAT and a 90-minute Enduro Race on SUN.

**"The Rumble" is part of the Cayman GT4 Clubsport race series**

Registration opens **Monday, May 8<sup>th</sup> 10:00 PM EDT**  
Through Club Registration at <http://register.pca.org>

Chairman: Phil Grandfield 757-635-0892 [FilthyF14@yahoo.com](mailto:FilthyF14@yahoo.com)  
Registrar: Scott Hoffman 301-247-4588 [scotthoffman11@gmail.com](mailto:scotthoffman11@gmail.com)



Phillip Hanson, Jeff Wiggins and Pat Heptig took the podium at the first ever Nationals West championship race at MotorSport Ranch in Cresson, Texas



The morning fog at Sebring threw the schedule off, but that didn't keep us from having fun!



Kerry Brown and #45 968 with SP3 944 Cup West Championship trophy (left)



Father and son drivers Manny and Manny Martinez, Jr (right)



944 SP1 finishing field at The Ranch at the 944 Cup Championship West includes (left to right) Dave Nelson, David Byassee, Ryan Viden, Stacie Virden, Phil Hanson, Jeff Wiggins and Pat Heptig

MOSPORT CAN-AM CHALLENGE 2017  
 Aug. 4 - 6  
 Practice, Sprints, Enduros  
 Aug. 3 Test n Tune



Come up and race with us at Mosport, one of the most challenging and legendary race tracks in the world. It's a racer favorite and under Ron Fellows direction, now a world class racing facility.

Join us, we've got a great event planned; four race groups, including the first GT4 Clubsport Series race in Canada; a separate Thursday Test and Tune and Canadian hospitality throughout.



For more information contact:  
 Terry Cassan: club-race@pcaucr.org  
<http://pcaucr.org/driving/club-race/>

ROCKY MOUNTAIN THUNDER AT HIGH PLAINS RACEWAY  
 PCA Club Race  
 June 17th & 18th, 2017

- In beautiful Colorado, just outside of the Denver metro area
- Fantastic track with elevation gains & unique track features
- Two sprints per run group plus a one hour Enduro, along with a fun race
- Access to the track beginning at 3 PM Thursday
- Test and Tune all day Friday (Not a PCA event)
- Brats, Brews & Blues party Friday night
- Hosted dinner Saturday evening
- Registration will open May 1, 2017 through ClubRegistration.net (<http://register.pca.org>)

ROCKY MOUNTAIN THUNDER HIGH PLAINS RACEWAY

Visit the race website and our facebook page to stay updated on the race details  
[www.rmclubrace.com](http://www.rmclubrace.com)

# EVENT ADS

PAGE	EVENT	DATE
21	2017 West Coast Series — 10 Races	see schedule
23	Carrera GT at MPG	June 2-4
67	Rocky Mountain Thunder at High Plains Raceway	June 17-18
65	Rumble at the Oak Tree, VIR	June 23-25
61	Stuttgart Challenge at Monticello Motor Club	July 14-16
29	BIR DE & Club Race, Brainerd	July 28-29
67	Mosport Can-Am Challenge	August 3-6
33	Schattenbaum Showdown, NJMP	August 18-20

(973) 773-3177 175 Passaic St Garfield, NJ 07026 [StableEnergies.com](http://StableEnergies.com)

# STABLE ENERGIES MOTORSPORTS

*The Largest Distributor of Motorsport  
Performance & Safety Equipment  
in the Northeast!*



## EXCLUSIVE CLUB RACING INSURANCE



**Chizmark Larson**  
Insurance Agency

On-Track Physical Damage Coverage  
Unlimited Use Annual Certificate Coverage  
Includes Club Racing Test & Tune  
HPDE/DE and Open Track Days

**815.725.6527**

We Specialize in Motorsports and Racing Insurance

Coverages We Provide:

- Storage
- Transportation and Paddocks (STP)
- Commercial Auto Coverage for Power Units and Trailers
- Race Prep Shop Coverage
- Collector Car Insurance
- See other coverages also available at: [www.ChizmarkLarson.com/motorsports.5.html](http://www.ChizmarkLarson.com/motorsports.5.html)





# MY JOURNEY INTO CLUB RACING AND SCRUTINEERING

STORY BY FRANKLIN PRAY, PHOTOS BY KEN HILLS PHOTOGRAPHY & JUHA LIEVONEN

My Driver Education “career” started about eight years ago while seconded job-wise to Ireland. I had the opportunity to purchase a beautiful 1993 911 RS America to be my dedicated DE car. Fitted with a clear bra, roll bar, harnesses, fire extinguisher and some race seats, it became my first track car.

DE events in Ireland were somewhat less, shall we say “structured” than what one would see in the US. Basically, I convinced the organizers that I wasn’t going to be a menace to others or myself on track, so I was left loose to drive solo right away.

The “crazy American” accumulated quite a bit of track time at the local Mondello Park just outside Dublin, then at Kirkistown Circuit, close to Belfast in Northern Ireland. My learning was rather trial and error based, but I made great friends with some of the nicest people. By the end of my stint in Ireland I was getting pretty familiar with the car, its noises and feel. I never really had any “offs” or spins, just enjoying the experience.

Back to the US I had to get adjusted to PCA DE run groups, tech inspections, car numbers, other rules and, of course, windows down, point

by and more tech inspections. I was signed off to go solo relatively quickly, but realized that I needed to change my *trial and error* learning approach to make some real progress.

I ended up with club racer Bob Turgeon as instructor, also a big fan of data analysis. We worked on skills development based on data and video analysis. Car control skills and skills execution took a giant leap forward and, of course, Bob suggested that I consider club racing - yea right!

By now I had accumulated so much support equipment, spares and tools, I continued down the slippery



## TRAQGEAR

Absolutely the best because we listen to our customers. Get safety and performance with TraqGear!

**Being cooler means being more alert! Get the TraqGear difference!**

[www.TraqGear.com](http://www.TraqGear.com)



**PODIUM LCG**  
SFI Certified Fire Retardant



**RACE PRO**  
Lightest Most Comfortable  
SFI Certified on the Planet



**EUROFIT**  
Semi-Compression Safe  
and SUPER comfortable



**PODIUM HPDE**  
Comfort Style Protection



## CSF COOLS PORSCHE

THE BEST PORSCHE TUNERS USE CSF

- CNC machined brackets, mounting pins and "Quick-Connect" inlet/outlet pipes
- 2 row core with B-Tube technology (+30% efficiency)
- Drop-in fit requiring no modifications
- All-aluminum 100% TIG welded
- Track Tested & Proven in 110°F
- 1 hour hand polished



Ultimate Performance Cooling

		88W/88A CSF	88W/82 CSF	88W/82 CSF
911 Carrera	Left	CSF	CSF	CSF
	Right	CSF	CSF	CSF
	Center	CSF	CSF	CSF
911 Turbo	Left	CSF	CSF	CSF
	Right	CSF	CSF	CSF
	Center	CSF	CSF	CSF
911 GT2	Left	CSF	CSF	CSF
	Right	CSF	CSF	CSF
	Center	CSF	CSF	CSF
911 GT3 / RS	Left	CSF	CSF	CSF
	Right	CSF	CSF	CSF
	Center	CSF	CSF	CSF
Boxster	Left	CSF	CSF	CSF
	Right	CSF	CSF	CSF
	Center	CSF	CSF	CSF
Cayman	Left	CSF	CSF	CSF
	Right	CSF	CSF	CSF
	Center	CSF	CSF	CSF
C74	Left	CSF	CSF	CSF
	Right	CSF	CSF	CSF
	Center	CSF	CSF	CSF

Find more at [CSFrace.com](http://CSFrace.com): News • Blogs • Features  
European & International distributors/dealers wanted! Inquire: [info@csf-race.com](mailto:info@csf-race.com)

Proudly distributed by





International Distributors





Exclusive Dealers







slope buying a tow vehicle and trailer.

The “your car is just too nice to drive on the track” comments had me convince my wife that it was safer to drive a purpose built car with full cage, fire system and all of the other amenities that make this sport safer.

Of course I should have never sold the RS America, but the requirement was that the new car was going to be an even trade. That’s how my 2006 Cayman S track car was born.

I commissioned a new build, avoiding the piece meal upgrade approach that I had with the RSA. I also splurged and commissioned Dan Porter to create a historic livery from the famous 911 RSA that won the Targa Florio in 1973. The only comment my wife made when she first saw the car was that it needed a wing. So, as a good husband, I always follow Rule #1 and we added a wing and front splitter.

I quickly realized that I needed more serious help to learn to drive this car, which had my own AIM MXL data system. I continued to work with Bob and other coaches like Rob Slonaker and Peter Krause.

I transferred to Connecticut Valley Region, which immediately demoted me (per their standard procedure) back to the instructed group. I met several club racers like Mike Ferra who also suggested that I consider PCA Club Racing - and now I listened.

Even though I had been signed off for solo DE again, I made a point of continuing to work with instructors and my private coaches and finally applied for my Club Racing License and “the talk with Susan”.

I had a fairly good season in my Rookie year, winning the relatively small Stock I class PCA National Championship, pretty much through consistency and being meticulously prepared. At this point, I was seriously hooked on this racing thing.

I had again made some great friends and learnt a lot. The bad part was that my friends started moving from Stock to GTB1, so I got myself some Toyo slicks and followed.



In my first GTB1 season I was like a novice trying to swim in the deep end of the pool, just trying to keep my head above water. Being an older Gen I Cayman, my car was relatively underpowered compared to the competition. I spent a lot of time with my coaches and Bodymotion, who maintained the car, to squeeze as much performance out of it as possible. Last year, my second season in GTB1, I ended up in second place in the National Championship, again pretty much through consistency and having a very reliable car.

In 2016 I decided that it was time

to “give back” to PCA, given all the great support I had received from the instructors and the local chapters. Many experienced DE drivers take the route to become instructors, but that was not an idea that my wife supported, given her perceived risks.

I had to find something else, so I called Vickie Earnshaw and, given my technical and data background, she suggested that I become a National Scrutineer, but this meant spending a couple of weekends a year at the track without racing myself.

Over the past year I learned a lot from the likes of Brent Knoll, Walt

Fricke and many other great PCA scruts. I learned a lot about car types I was not familiar with, learned a lot about establishing policies, procedures and training for the PCA “Black Box” data systems.

Most importantly, I became very impressed by the dedication of my fellow scruts, the timing and scoring team and the stewards who were running high quality events. Club races can often be chaotic due to technical malfunctions, weather and on-track incidents and, frankly, most racers would never notice.

My own racing career recently received an upgrade with a newer 2012 Cayman, which finally generated more of a level playing field with all my friends in GTB1 and, after some initial teething problems that the Bodymotion Team mastered quickly, we’re off to a promising start for the 2017 season.

The absolute hardest part about scrutineering for me, aside from making the time available to spend



another weekend away from home, is not being out on a track with the other racers.

However, the PCA Club Racing organization is dependent on volunteers so, if any of you have some in-

terest in giving back to the system, seriously consider becoming part of the team, whether as a scrutineer or in timing and scoring or otherwise.

A call to Vickie is all you need to get you started. ❏

**RED LINE**  
SYNTHETIC OIL

**MOTOR OIL**  
FULL SYNTHETIC

**40WT TRACE**  
MULTIGRADE SAE 15W40 WITH EXTRA ZDDP  
FOR RACING ENGINES ONLY

1 U.S. QUART • 946 ml

**DECADES LATER,  
STILL THE BEST.**

**RED LINE**  
SYNTHETIC OIL

- ESTER BASED: BETTER FILM STRENGTH THAN BRAD PENN AND DRIVEN!
- MORE THAN 2200PPM OF ZINC
- LONGER DRAIN INTERVALS
- REDUCED FRICTION FOR LESS WEAR AND INCREASED POWER
- A 15W40 FOR AIR-COOLED AND WATER-COOLED PORSCHEs

**HRP** **OG RACING** **TTM**

**WORLD PAC** **Wine Country Motor Sports**

To find your local dealers or distributors: 800.624.7958 | REDLINEOIL.COM



# 2017 HARD CHARGERS

BY MICHAEL WINGFIELD, CHIEF OF NATIONAL TIMING & SCORING

Name	Region	Class	Description	Start	Finish	Index	Race
<b>CIRCUIT OF THE AMERICAS — MARCH 3-5</b>							
Frank Kovacevic	RED	GTA1	GT 01 996 GT3 Cup	44	21	23	Blue Sprint Race 1
Dave Elsner	RIV	GTC6	GT 13 991	27	6	21	Blue Sprint Race 2
B Buchheit / D Aspesi	LA	GTA2	GT 07 GT3 Cup	31	14	17	Blue Enduro
Sean McLean	LST	SPB	P 98 Boxster	31	12	19	Red Spring Race 1
Price Ford	MSO	K	S 07 GT3	25	11	14	Red Sprint Race 2
Michael Hsu	HCT	SPB	P 99 Boxster	38	11	27	Red Enduro
<b>SEBRING INTERNATIONAL RACEWAY — FEBRUARY 3-5</b>							
Michael Hemingway	RMT	SPB	P 98 Boxster	14	13	1	Orange Sprint Race 2
Omar Hilmi	POT	G	S 91 911	24	13	11	Green Sprint Race 1
Evan Close	POT	E	S 84 911	27	15	12	Green Sprint Race 2
Enrique Munizaga	FLC	GTB3	GT 06 997S	36	24	12	Red Sprint Race 1
Geof Isringhausen Jr	LTR	GTB1	GT 12 Cayman R	35	24	11	Red Sprint Race 2
David Dunigan	SCH	SPB	P 97 Boxster	39	15	24	Black Enduro
Anthony Brown	MNY	G	S 09 Cayman	36	24	12	Purple Enduro
J Lombardo / C Herr	NOO	GTC5	GT 12 GT3 Cup	28	4	24	Pink Enduro
<b>THUNDERHILL RACEWAY — MARCH 18-19</b>							
Michael Tsang	GG	SPB	97 Boxster	19	14	5	Sprint Race 1
Charles Krause	GG	SPB	98 Boxster	18	15	3	Sprint Race 2
Robert Murillo	GG	SP911	85 911 Carrera	9	6	3	Sprint Race 3

# The Classifieds

BUY, SELL AND BROWSE

## GT1 RACE CAR

Conceived and constructed to be a top flight PCA Club Race car. Before the Porsche factory found that their 911 RSR race cars will be more competitive with a mid engine chassis, we built this car. A few of the features: it uses a 914 tub as required by PCA CR rules at the time, 993 suspension both ends, center steering position, full tube chassis, fully adjustable suspension mounts, 993 GT1 body shell, 11.5 ft & 14.0 rear wheels, extremely low weight, built using best components available

If you have interest in a car that's easy to drive and very competitive in all phases of motorsports, please contact Ron Mistak at [rjmistak@gmail.com](mailto:rjmistak@gmail.com)

Price 95,000.00 Interesting trades considered (17.2)



## 2004 996 GT3 J Stock Champion

K-Fab 1.75 DOM roll cage, PCA legal nets, harness, halo seat on sliders... Moton Clubsport 2 way shocks with custom valving, serviced 2015... RSS suspension components, Numeric billet shifter, Aim data and camera... Fresh trans 2015 with fresh Guard diff... Fresh Bavaro built engine 2015 incl new wire harness... FVD exhaust, custom intake, cool suit system... 3 sets CCW race wheels 1 set stock GT3 wheels with new Hoosier rains... Many new or freshly serviced components. This car has been maintained and extensively developed by Bodymotion over the last few seasons. Many track records and countless class wins.

2016 PCA J class National Champ!

\$61,000 Geoff@bodymotion.com (732) 493-2700 (17.3)



## 2012 CAYMAN S CLUB RACER

Car is a proven winner, sorted and ready for track Sprints or Enduros, JTZ RS@ Shock Kit, front Brembo Clubsport big brake kit, CF doors, splitter and rear spoiler, AIM in car camera system, Speedcom Radio system, Cool Suit and Helmet Air System, (2) sets tires and rims wet/dry – too many extras to list & some spares, car is super reliable has 6 to 7 weekends on engine and ready to track or race. Have enclosed (AC) Trailer and Dully if interested.

Car is at \$ 94,500 OBO for more Info Contact: Robert Booth (305) 218-0691 or [rbooth55@icloud.com](mailto:rbooth55@icloud.com) (17.2)



## 2006 CAYMAN S - PROVEN DE/CR CAR

6-Speed, cage, fire system, OMP halo seat, billet Motorsport shifter, Cool Suit, AIM Pista Dash Sys & Smarty HD Bullet cam w/ full ECU integration. Motorola Radio. Monoball suspension, freshly overhauled JRZ RS PRO dampers. Only 14 hours on fresh overhaul engine. Too many options to list. Very light - impeccably maintained and very well set up. The perfect car to race competitively in Prepared I, Stock H or Spec Cayman. Asking \$60,000

Contact: Frank Pray (917) 940-6895 [fpclp@yahoo.com](mailto:fpclp@yahoo.com) (17.2)



## AIM Data and Video Products



MXL 2



MXG



SC HD Gen 2



SOLO DL



SC HD GP



EVO 4 w/ G-Dash

Authorized Dealer Since 2008  
PCA Member since 1993

**Austin Motorsports LLC**  
[www.austinmotorsportsllc.com](http://www.austinmotorsportsllc.com)

Ask for PCA Discount  
941 228 8964



## A DAY AT SEBRING

STORY BY GARY BENNETT

PCA's 48 Hours at Sebring Club Race. My colleague and I were impressed by Charlie and Jeff, the veteran SCCA officials working the turn. Waiting for the morning fog to lift, they patiently explained our duties and demonstrated the various flags deployed to warn approaching drivers of the occasional hazard lurking just out of view around Turn 7, an exciting hairpin in front of Chateau Elan, following a long straight.

With each successive race, we slowly but surely progressed to being useful "eyes and ears" for these gentlemen, spotting various mishaps and getting the word out through flags and headsets. It was also an opportunity to learn a bit more about driving

technique at high speed, including last-minute braking and centrifugal loading on the tight turn.

Following our volunteer shift, we had the opportunity to dine and chat with fellow club members, sporting our newly acquired, one-of-a-kind Sebring 48-Hour t-shirts.

All-in-all, it was an exciting and educational experience that we highly recommend to other PCA members. It is something you don't get to do every day

Involvement comes in many forms... sometimes not behind the steering wheel!

Gary Bennett  
2006 Porsche Cayman S

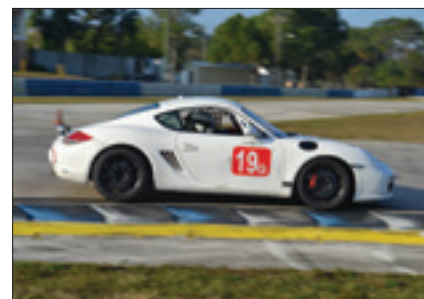

Introducing

**BRS**  
Bilt Racing Service

exclusive

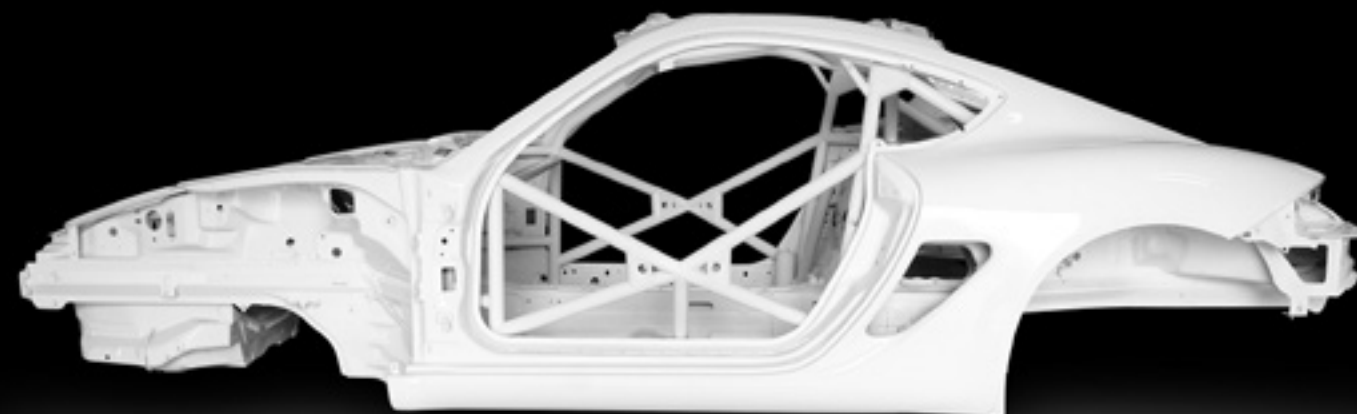

## "Body In White" program

PERFECT START TO A RACE CAR PROJECT  
OR REBUILD OF A CRASHED CAYMAN® RACE CAR

BRS rollcage tied in from front to rear strut towers

Can be sold with composite body panels

Acid dipped after rollcage installation

One in stock at all times

Base clear white paint



**BRS**  
Bilt Racing Service

Bilt Racing Service  
tel. (815) 582.7268  
info@biltracingservice.com



### National Committee

#### Club Racing Chair

Vicki Earnshaw  
7161 South Lewis Street, Littleton, CO 80127  
720.244.1532  
vicklm@aol.com

#### Club Racing Co-chair & Chief Steward

Bryan Henderson  
2416 Bedford Circle, Bedford, TX 76021-1822  
817.845.2664 (fax) 817.345.6045  
Bryan@BPHMS.com

#### Program & License Coordinator

Susan Shire  
1897 Mission Hills Lane, Northbrook, IL 60062-5760  
847.272.7764 (fax) 847.919.6862  
PCAClubRace@aol.com

#### Chief Scrutineer

Mike Mulligan  
1304 North Melrose Drive, Suite B, Vista, CA 92083  
760.672.9175  
Mugs914@yahoo.com

#### Chief of Timing & Scoring

Michael Wingfield  
3805 Clearwater Court, Plano, TX 75025-2094  
972.491.2766  
Wingfield@juno.com

#### Technical & Rules Coordinator

Walt Fricke  
4651 Huey Circle, Boulder, CO 80305  
303.499.6540  
WalterFricke@msn.com

#### Sponsor Coordinator

Vu Nguyen  
P.O.Box 6400, Columbia, MD 21045  
410.381.0911  
ExecutiveDirector@pca.org

#### Printing

Innovative Printing Solutions  
SolutionsDianna@aol.com  
760.420.1950

Copyright 2017 / Porsche Club of America

## ADVERTISER INDEX

Apex Performance .....	19
Austin Motorsports .....	74
Autometrics .....	51
BBS Wheels .....	BC
BRS / LN Engineering .....	25
CARQUIP .....	59
Chizmark Larson Insurance .....	68
Club Racing National Sponsors .....	35
COBB Tuning .....	55
CSF Radiators .....	71
CupCar Solutions .....	51
Demon Speed Motorsports .....	65
EBS Racing.....	57
Forgeline.....	53
Hollinger .....	43
Hubstands .....	39
JX2 Performance Group.....	37
KW Suspension.....	8
Millers Oils .....	31
Motion Control Suspension (MCS) .....	13
Moton Suspension Technology .....	33
Northstar Motorsports .....	IFC
OG Racing.....	IBC
PFC Brakes .....	77
Red Line Oil.....	73
Slide Rule Motorsport / Zimiki Coaching .....	59
Softronic.....	11
Stable Energies.....	69
Strategies for Wealth .....	36
Sube Sports .....	49
TC Racing .....	21
TOYO Tires .....	15
Traqgear.....	71
World Motorsports.....	39

## CLUB RACING NEWS STAFF

#### Editor

Skip Carter  
10385 Bonnie Lane, La Mesa, CA 91941  
619.992.9927  
SkipCarter@pobox.com

#### Advertising Coordinator

Ilko Nechev  
5030 Broadway #825, New York, NY 10034  
646.644.2796  
ilko@pca.org



1.800.934.9112 | www.ogracing.com

# OG RACING

## Got Brakes?

## The OG-Racing PFC Guarantee

It's easy. We're so sure that you'll like PFC's pad compounds that we're going to guarantee it! Buy a set of PFC pads and try them out for a weekend - if you don't like them, we'll exchange them for the Pagid or Hawk pads of your choice (or equivalent store credit). Visit the link below for all the details.



**Learn more: [ogracing.com/performance-friction-brakes](http://ogracing.com/performance-friction-brakes)**

Program Details: PFC Brake Pad Guarantee applies to any purchase of current PFC pad compounds, shapes & applications. Discontinued or special order part numbers are not eligible for this program. Pads must be returned after ONE event or within 30 days (whichever comes first). Pads may be exchanged for an equivalent Pagid or Hawk shape OR OG-Racing Store Credit up to the purchase price of the returned pads. Other terms or limitations may apply. OGR Inc reserves the right to cancel or modify this program at any time and for any reason.



# BBS

Technik aus dem Motorsport

*From Track To Street, BBS is the Best Choice. Never Compromise!*

BI-A  
Track Pkg. 18"  
From 3940

FI-R  
19" -21"

Track Day 19"

991 GT Am. 18"

BBS Motorsport | 770-967-9574 | [www.BBS-USA.com](http://www.BBS-USA.com) #raceproven

